

U AFSTRIJKERS

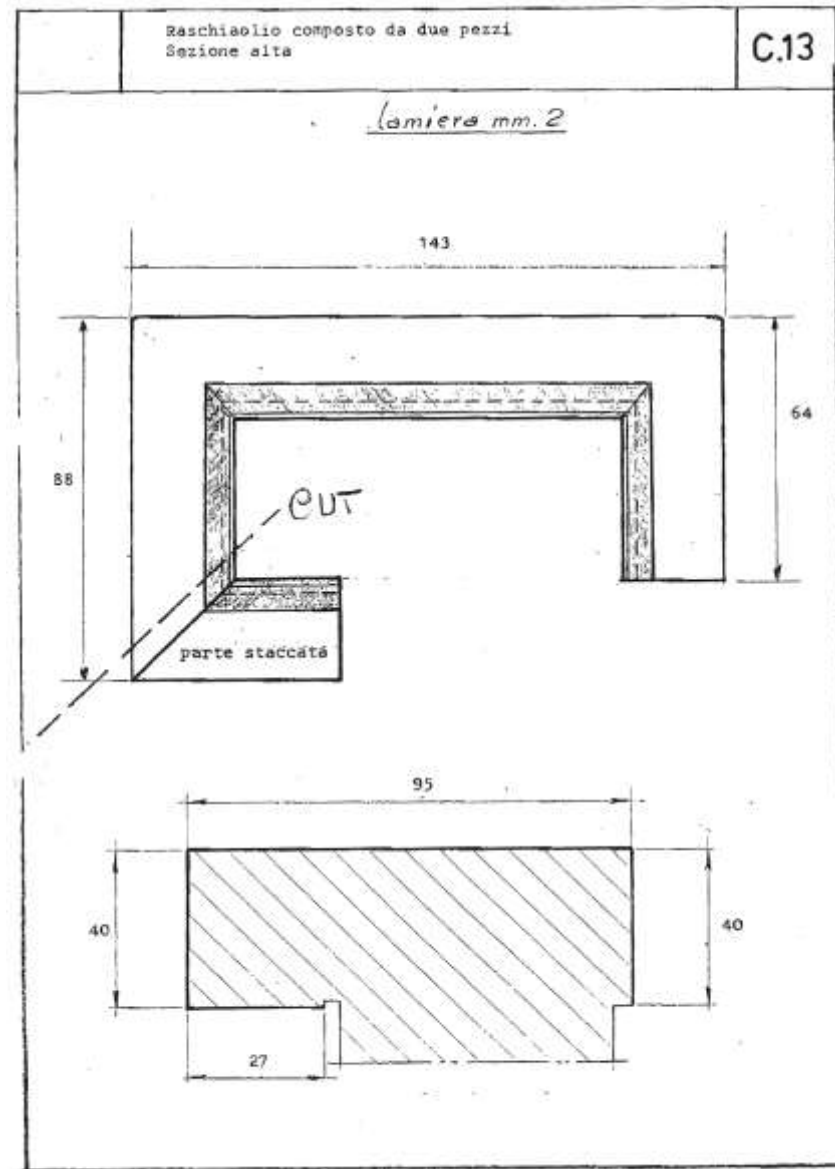

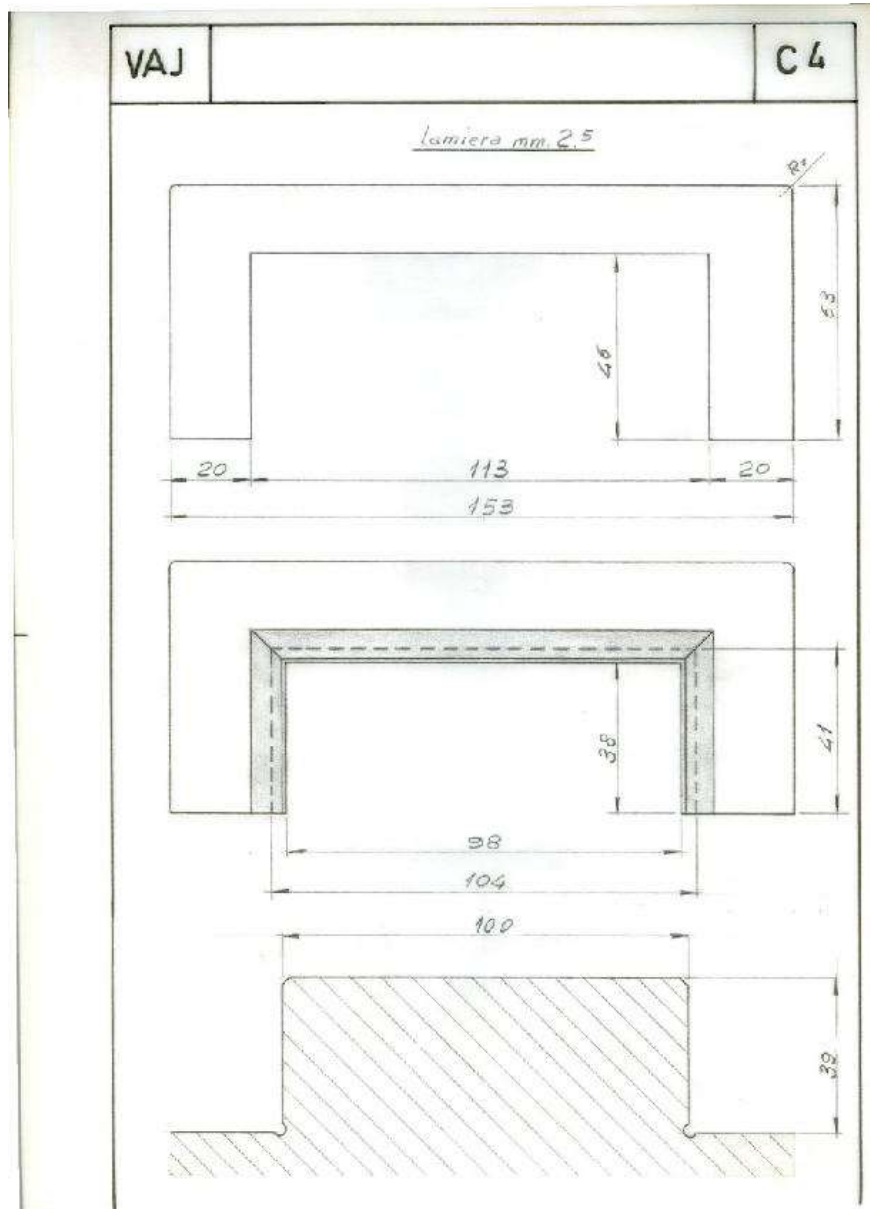

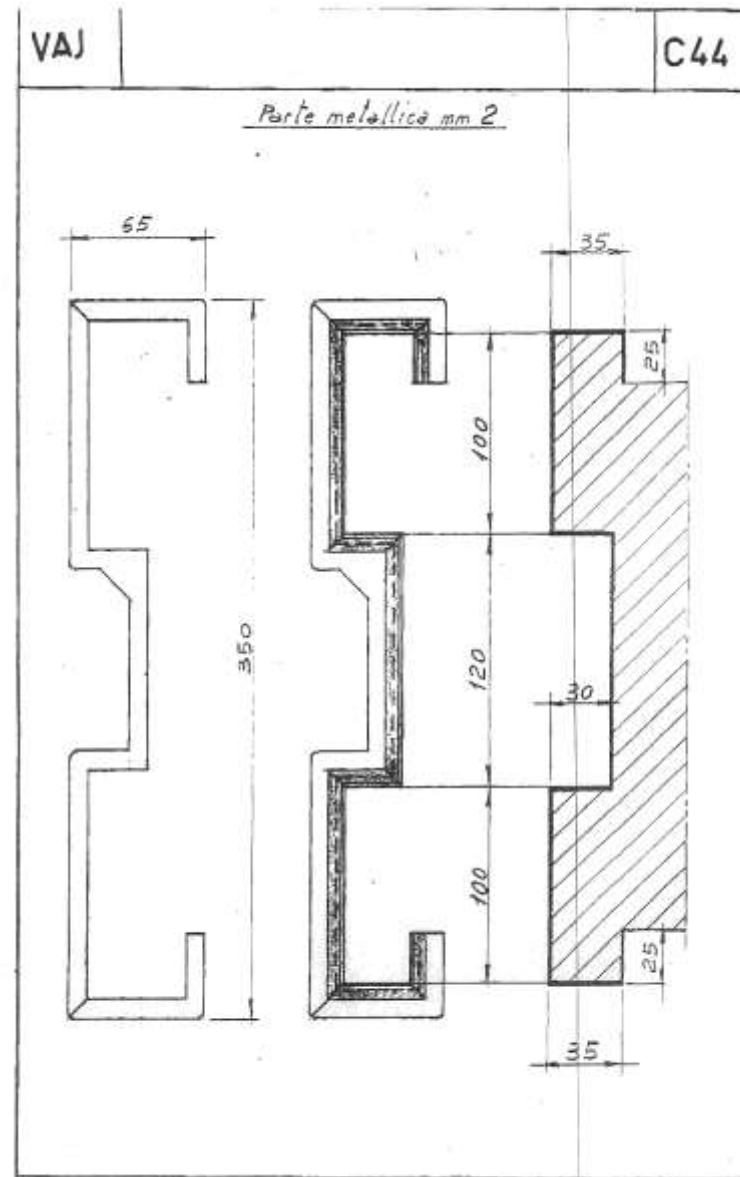

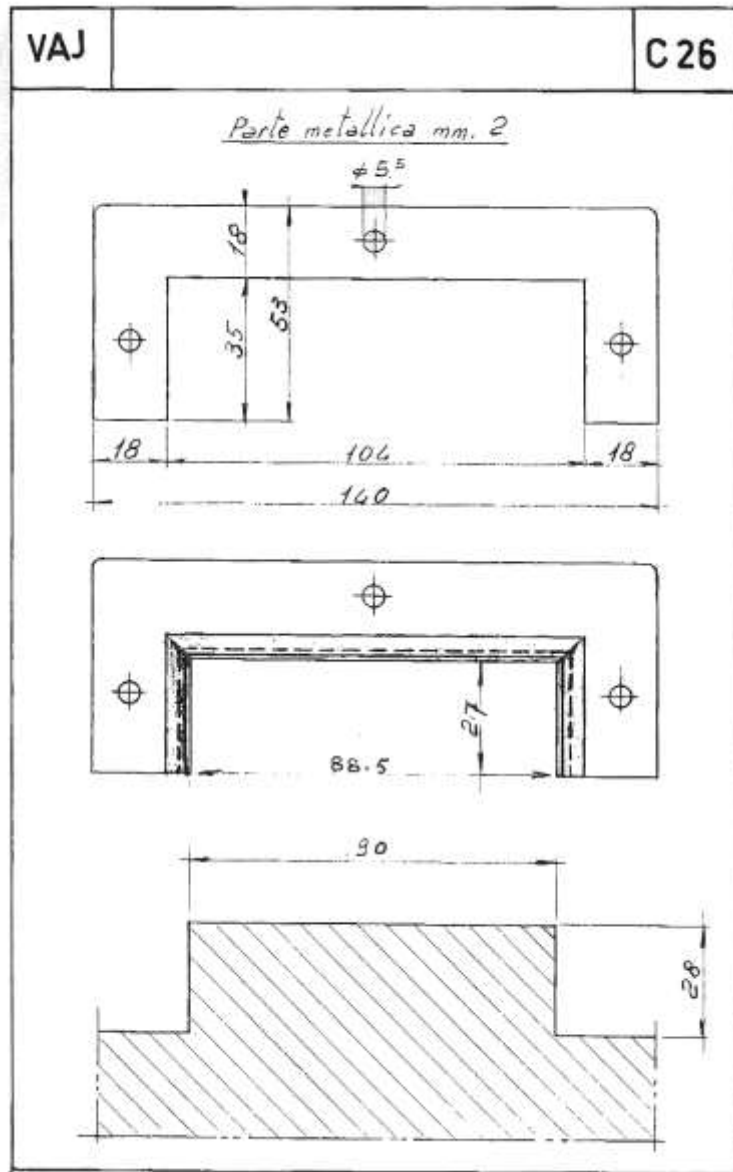
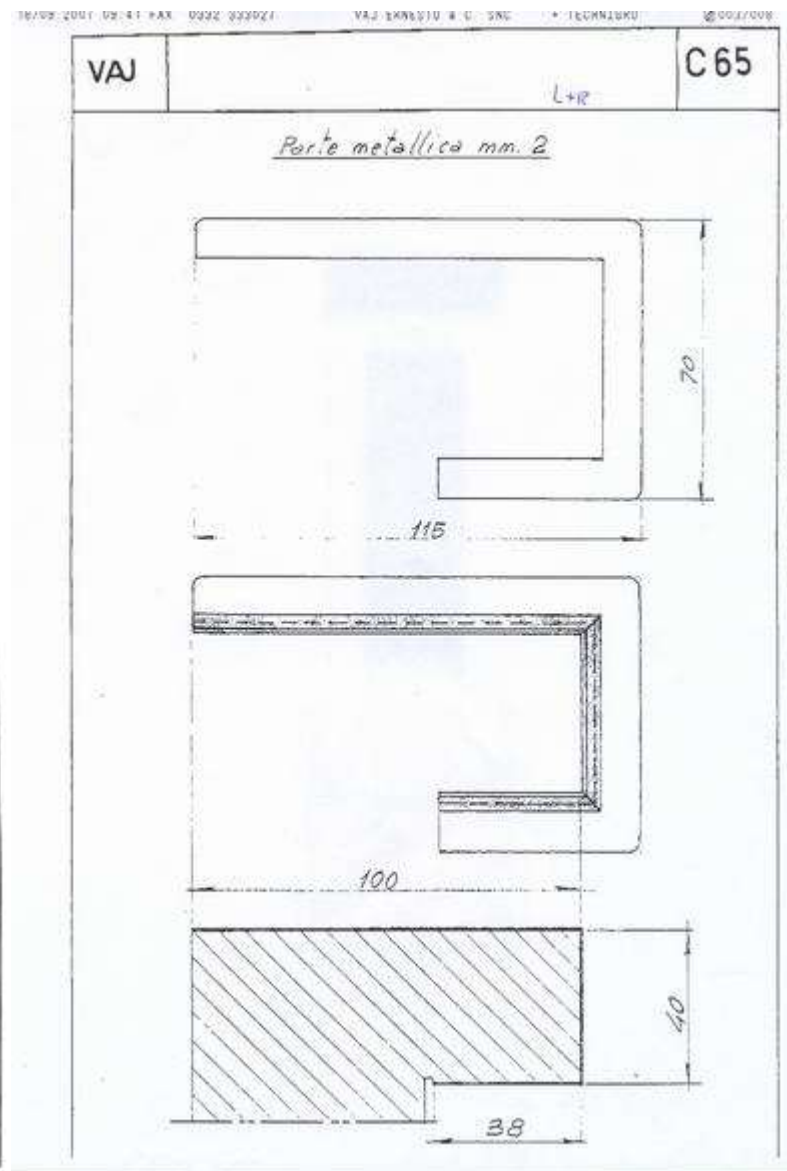
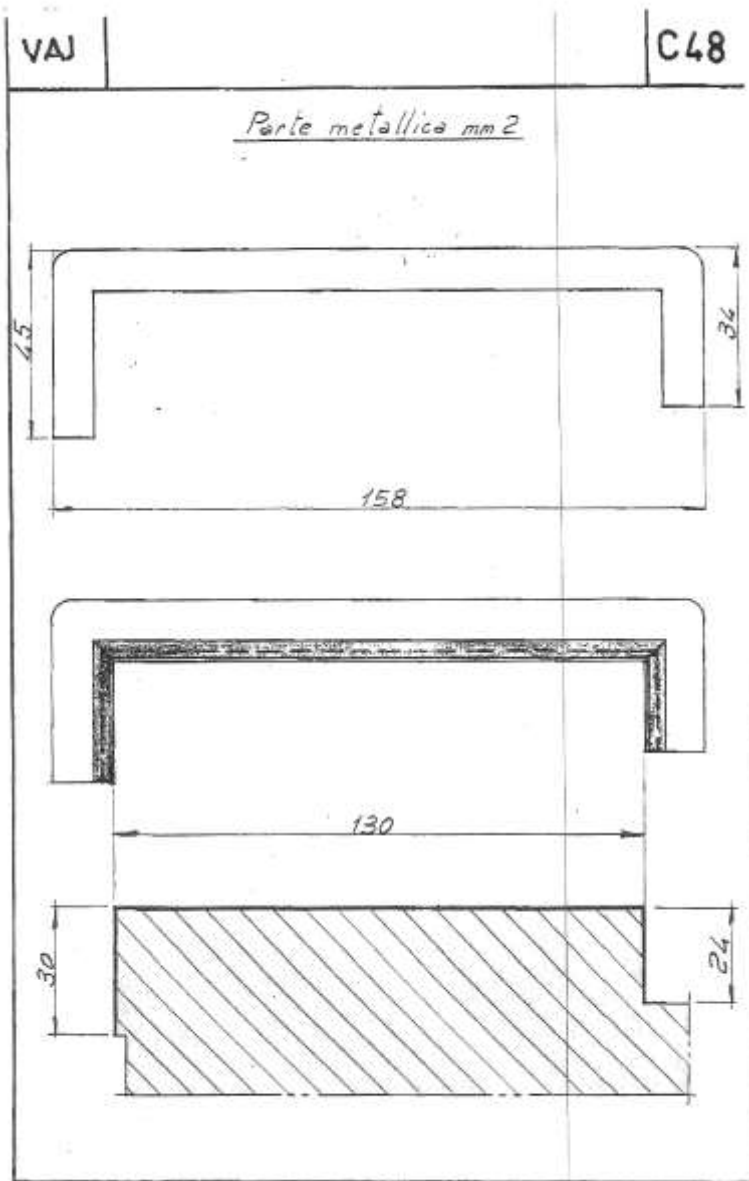

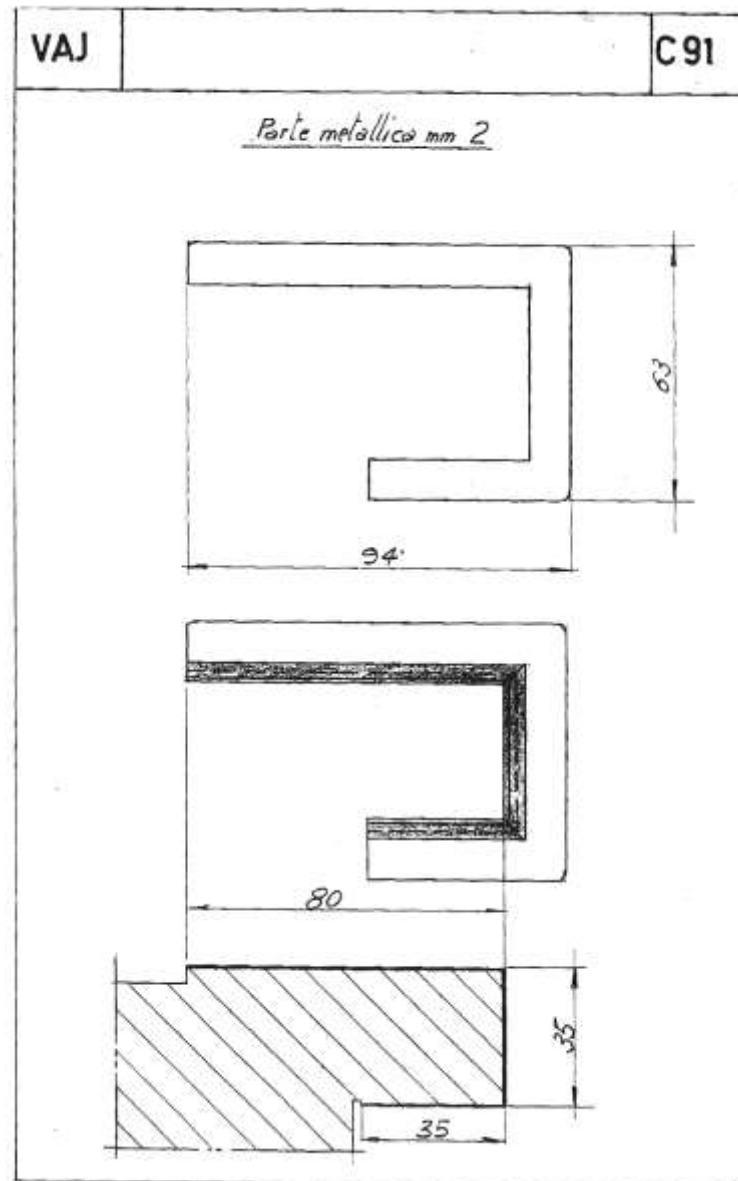
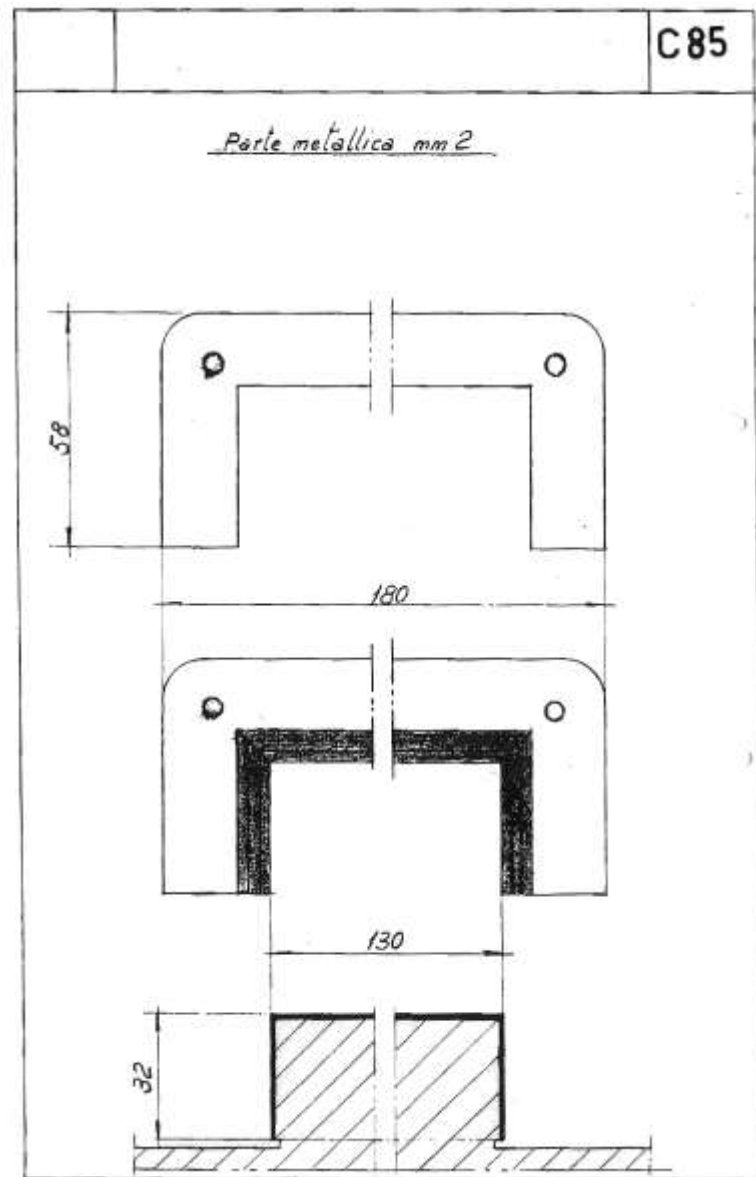

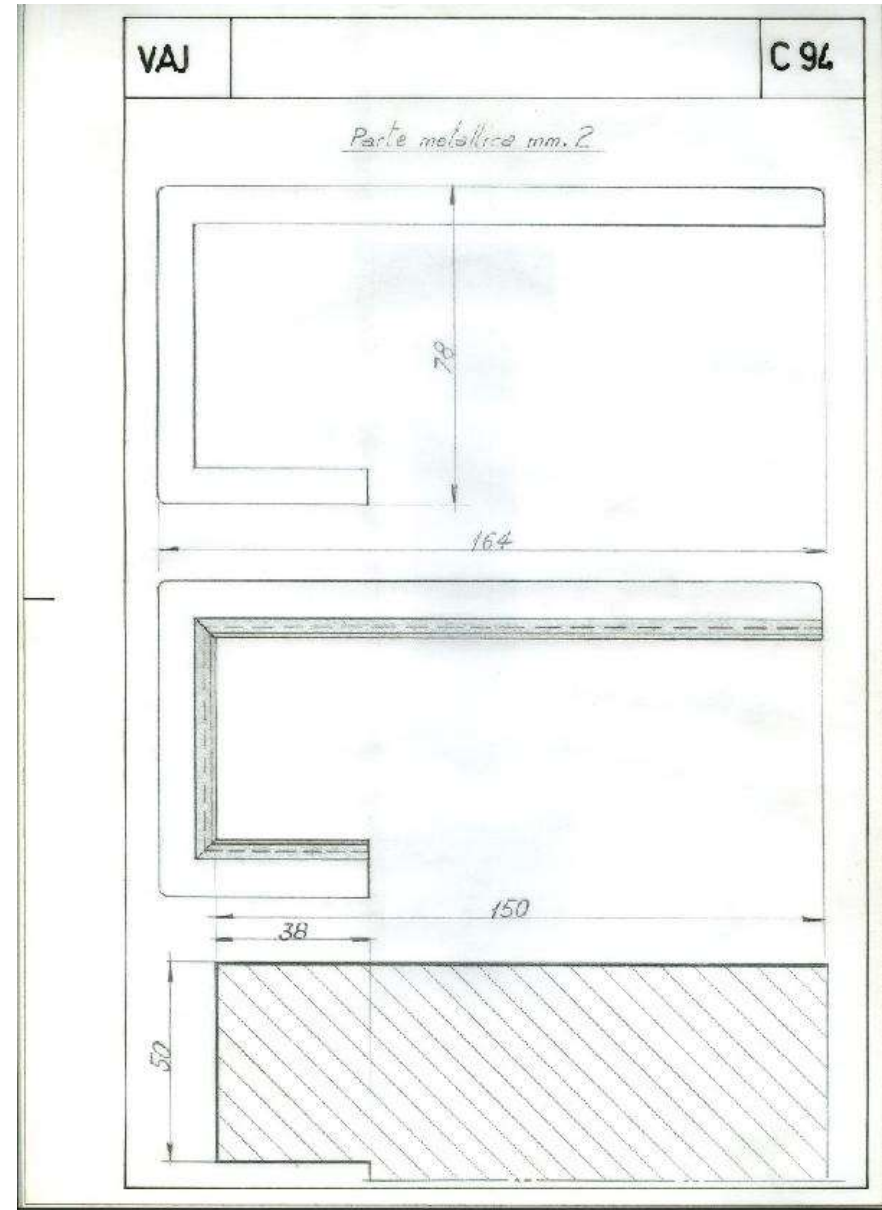
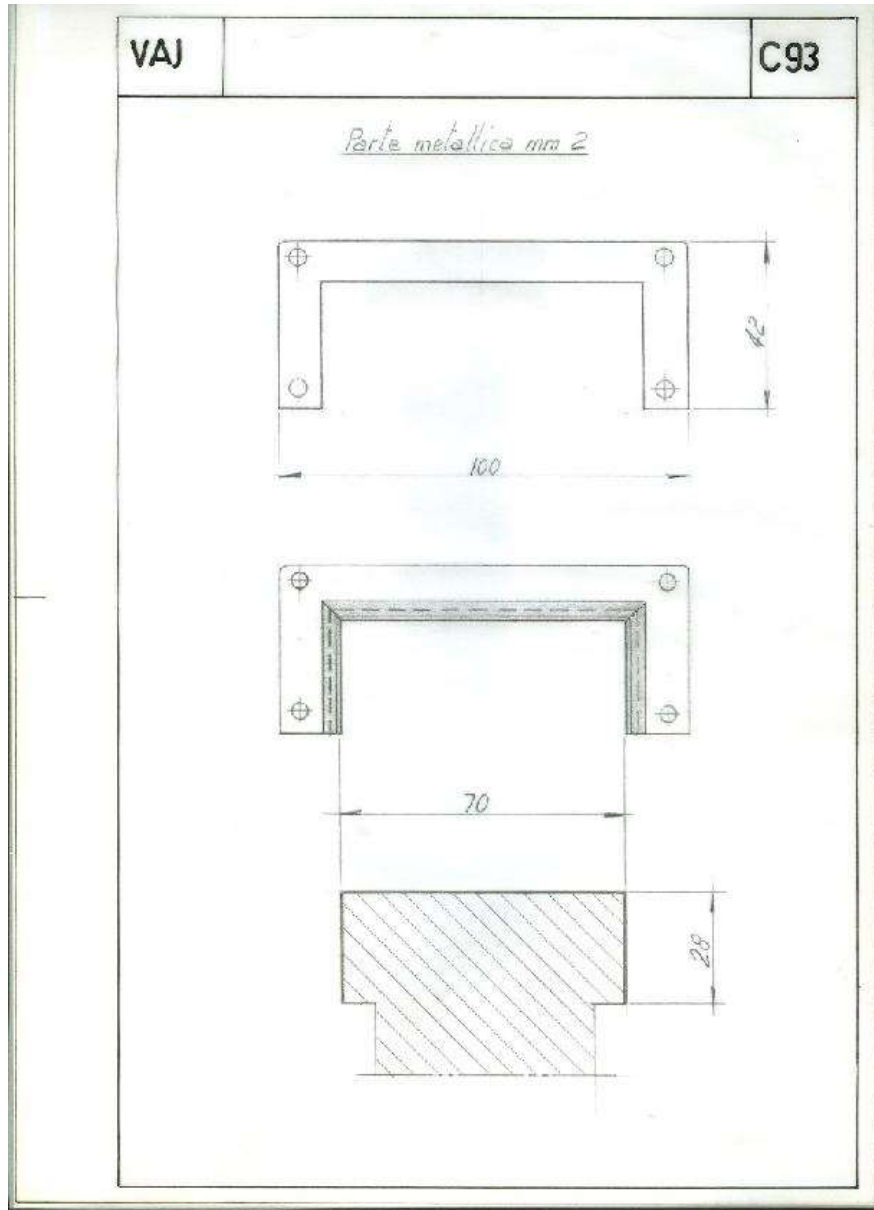

VAJ

C122

Parte metallica mm 2

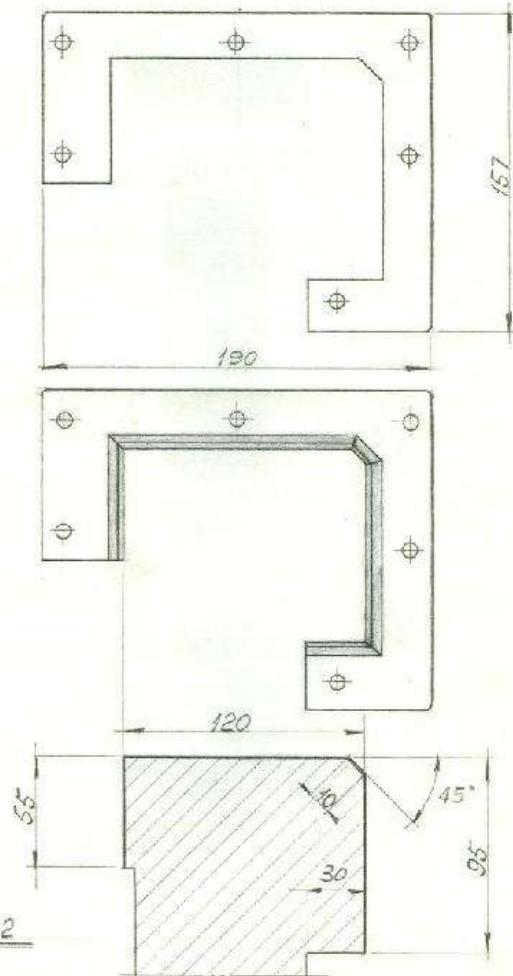

Scale 1:2

VAJ

C123

Parte metallica mm 2

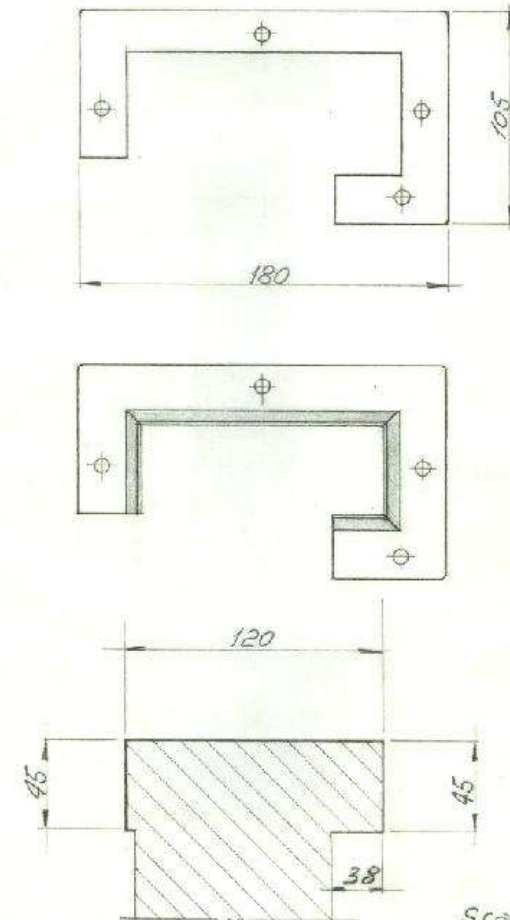

Scale 1:2

VAJ

C 158

Parte metallica mm 2

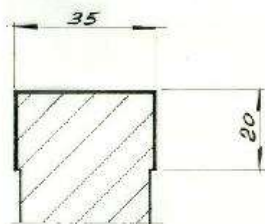
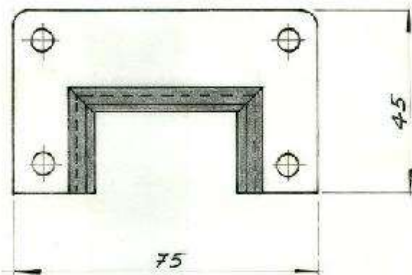

VAJ

C 160

Parte metallica mm 2

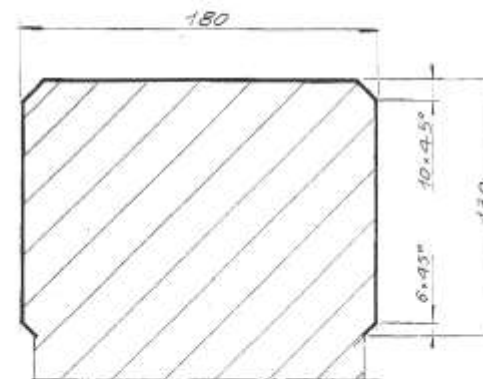
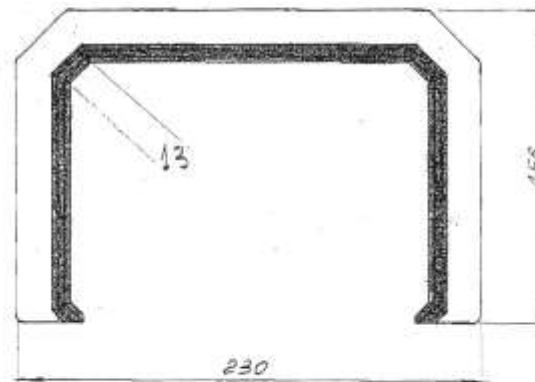

Scala 1:2

VAJ C 165

Parte metallica mm2

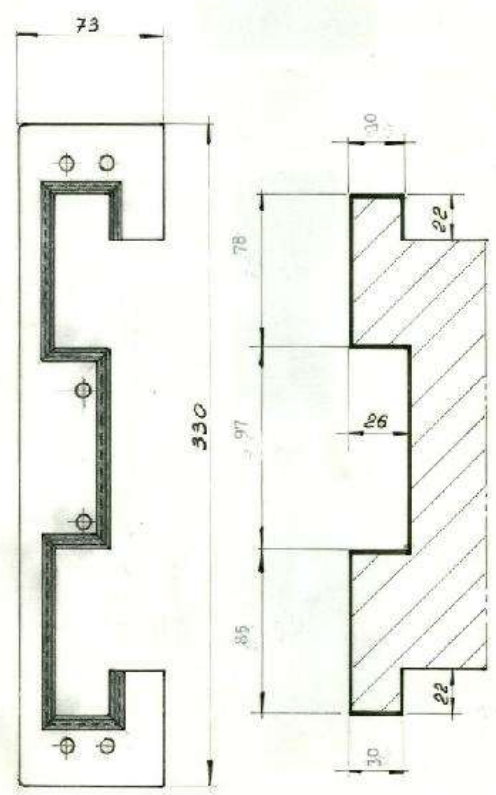

Scala 1:2

VAJ C 176

Parte metallica mm2

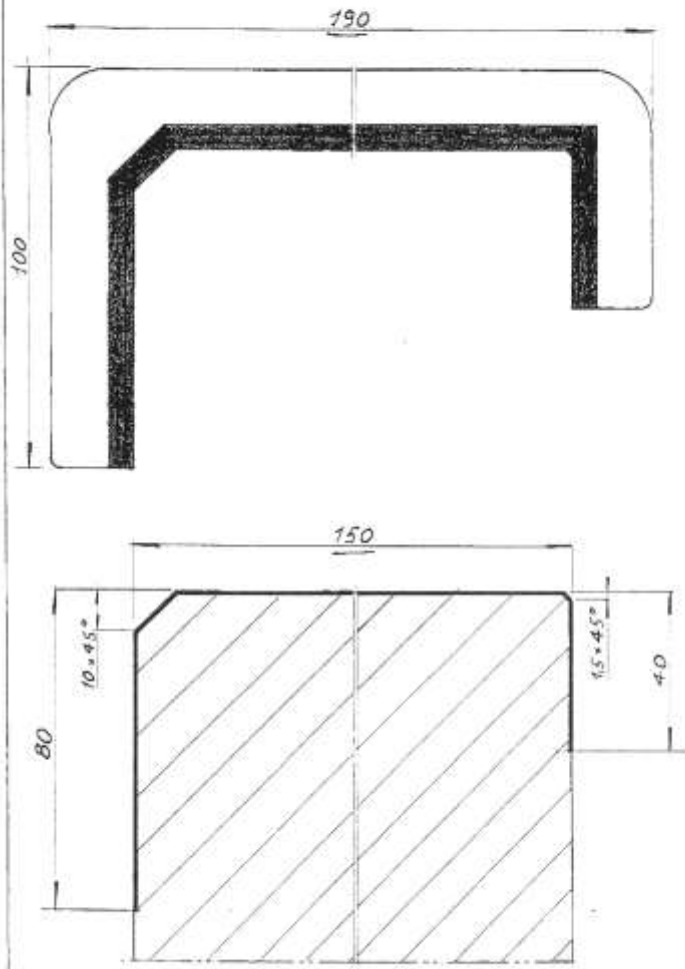

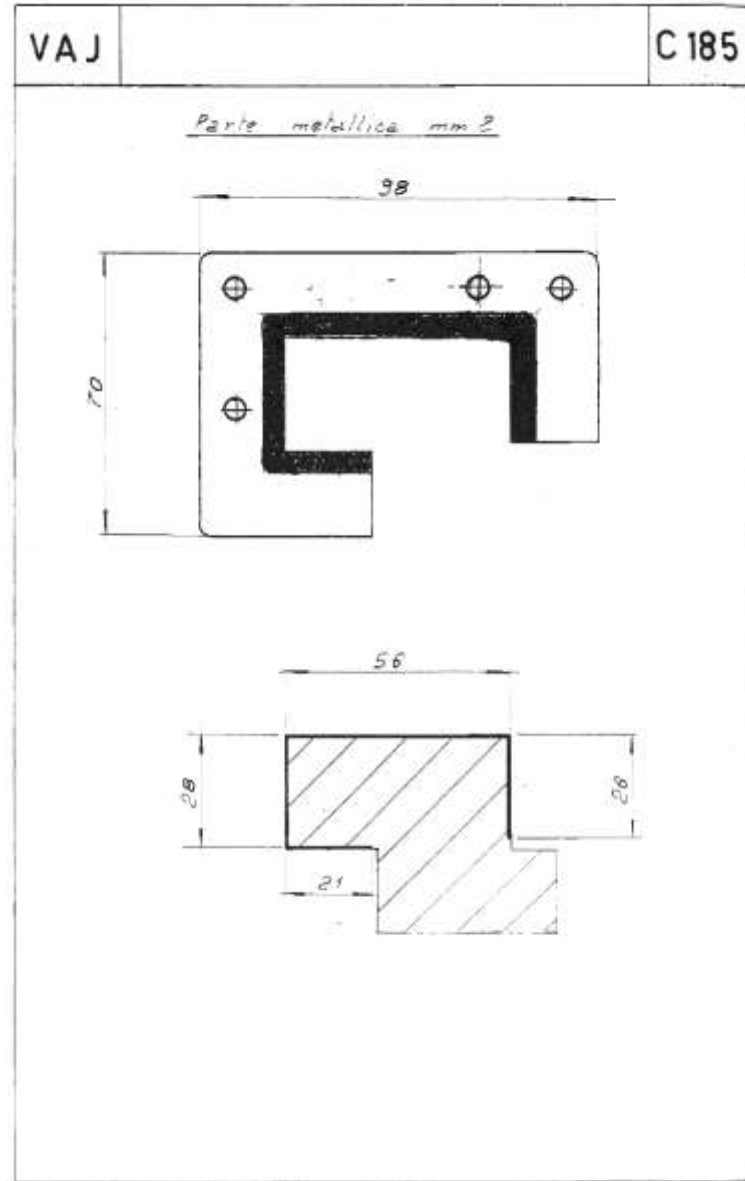
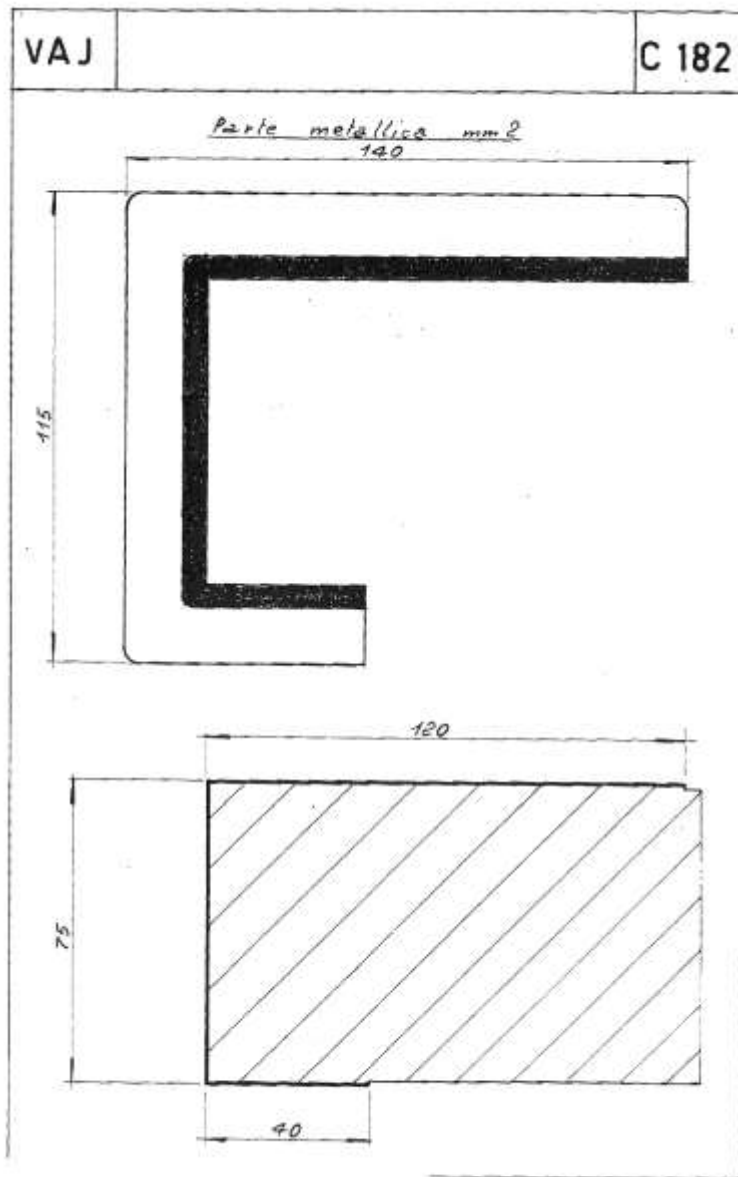

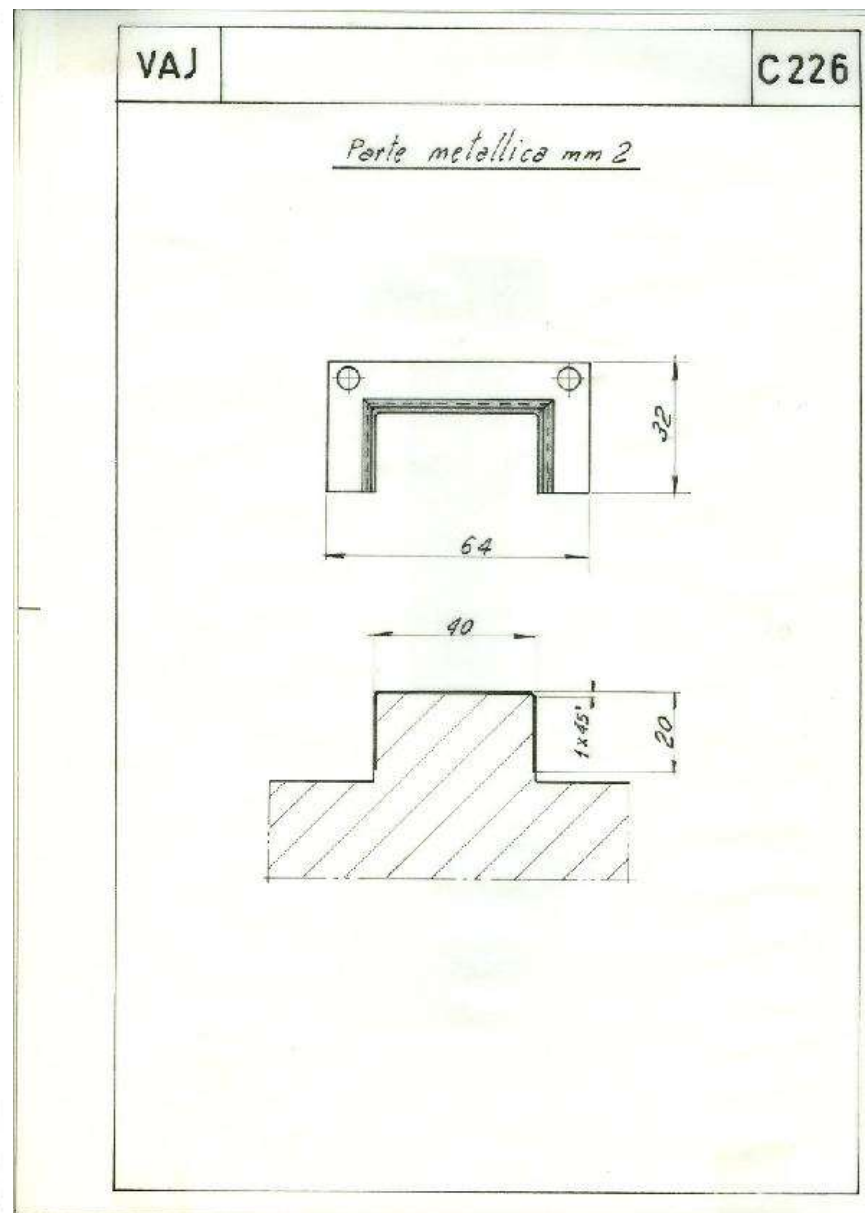
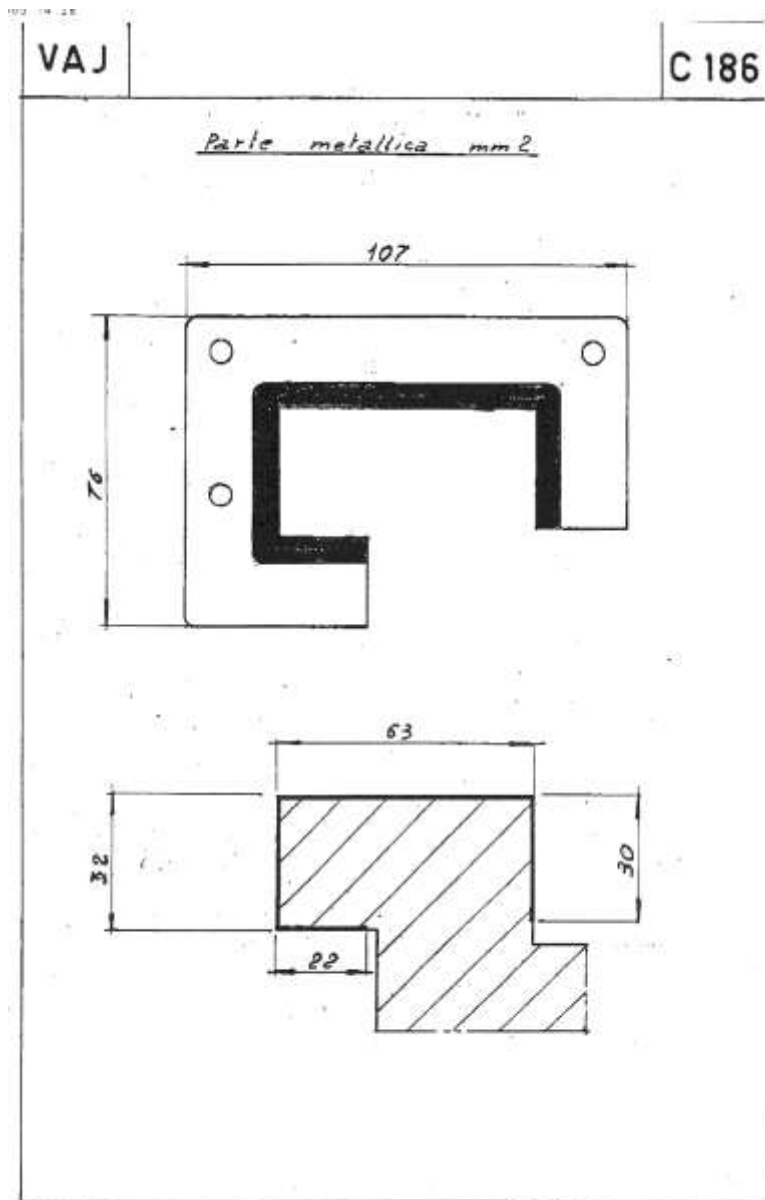

VAJ

C227

Parte metallica mm 2

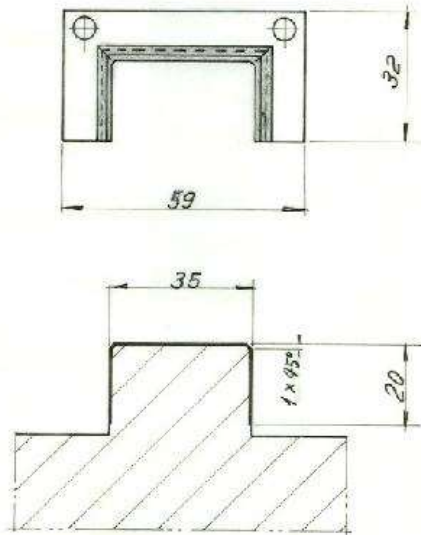

VAJ

C255

Parte metallica mm 2

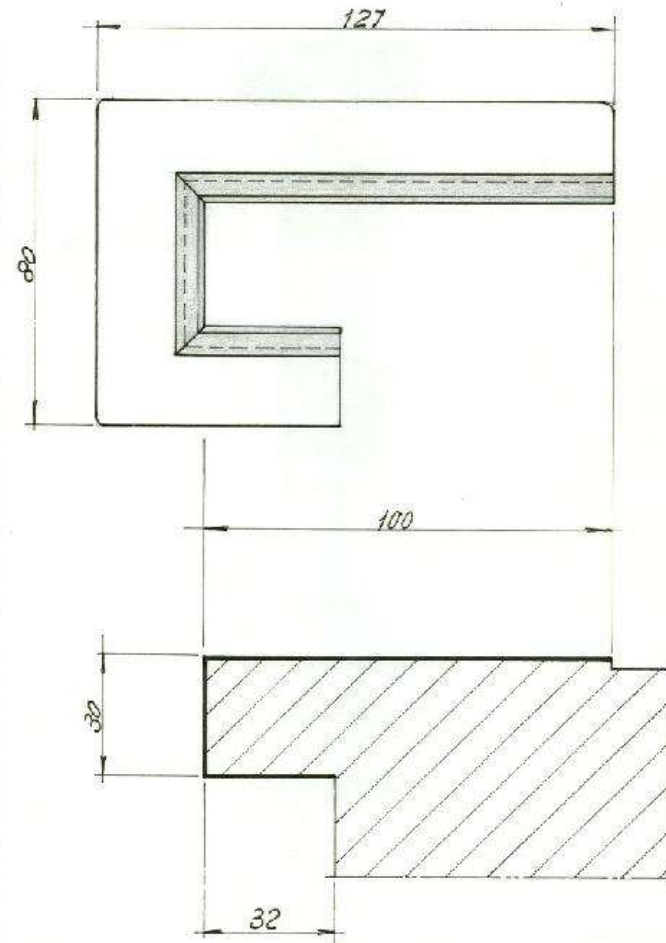

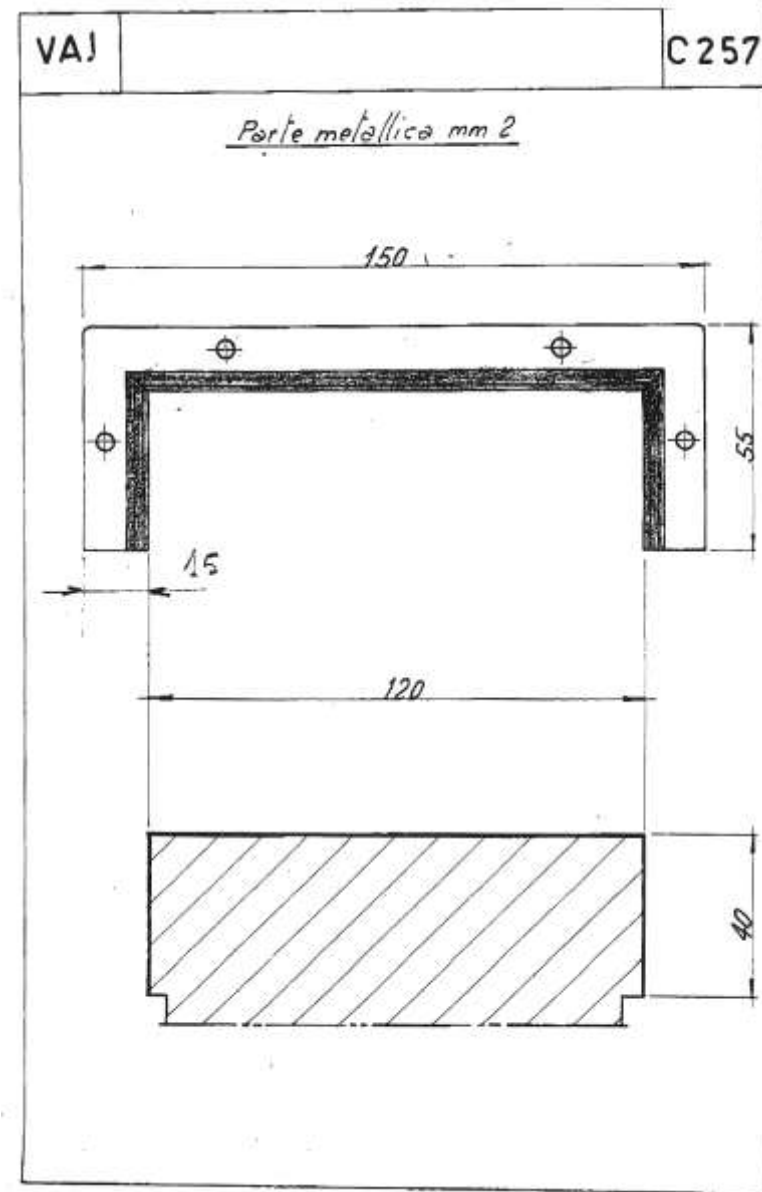
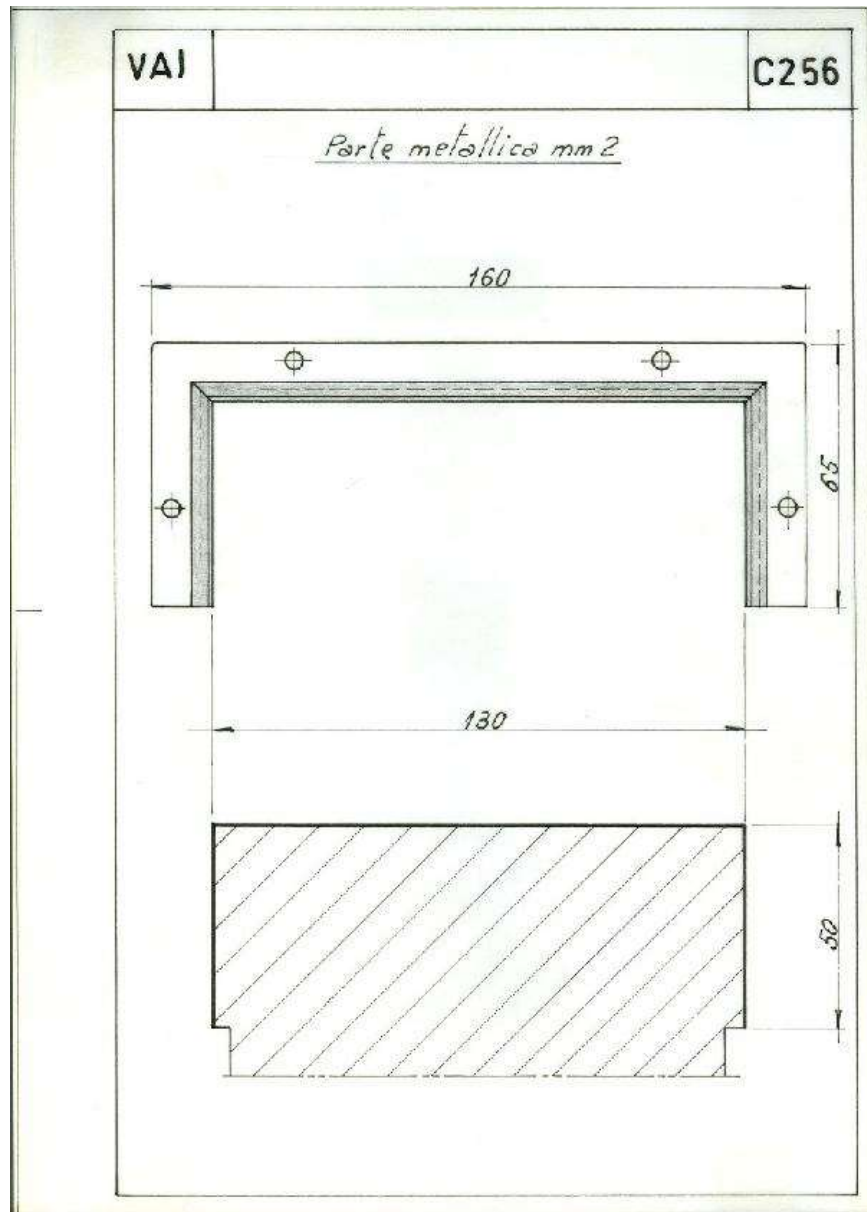

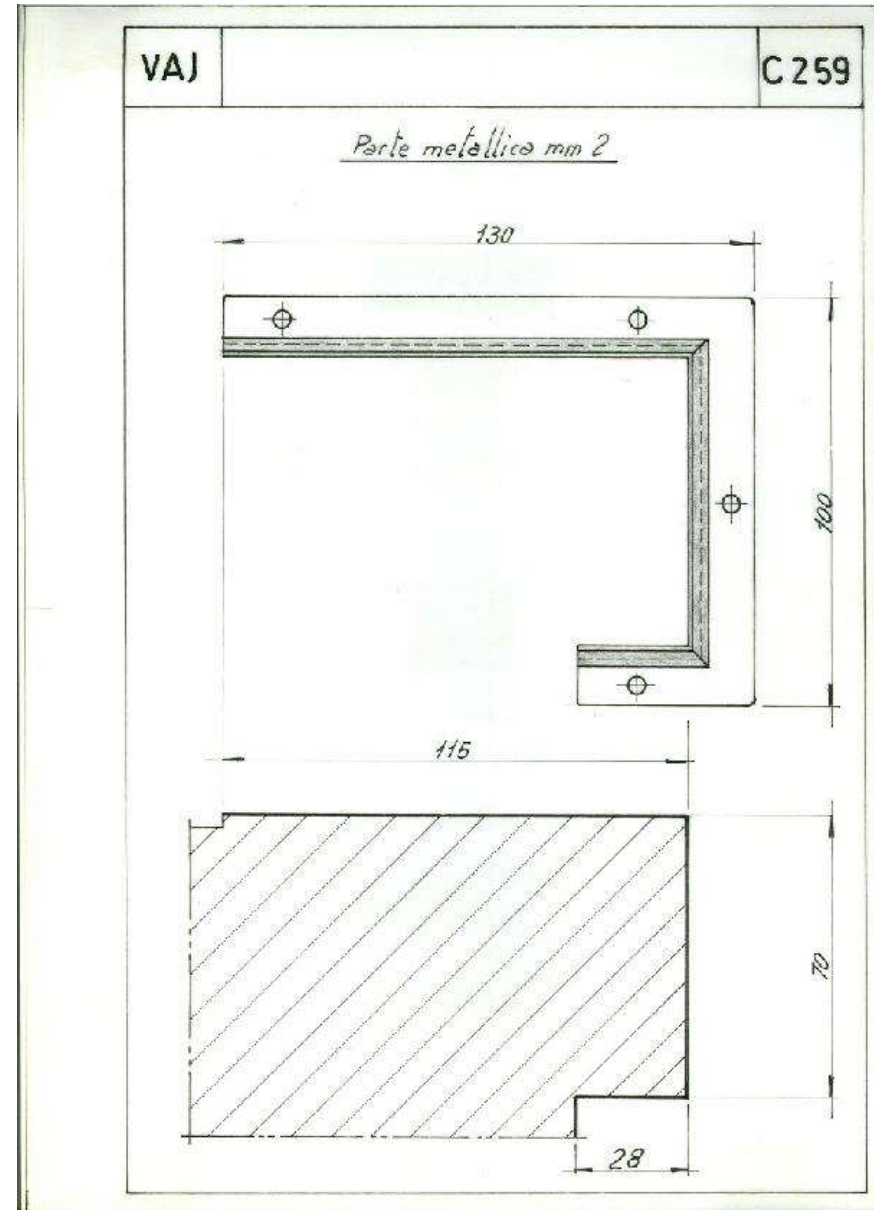
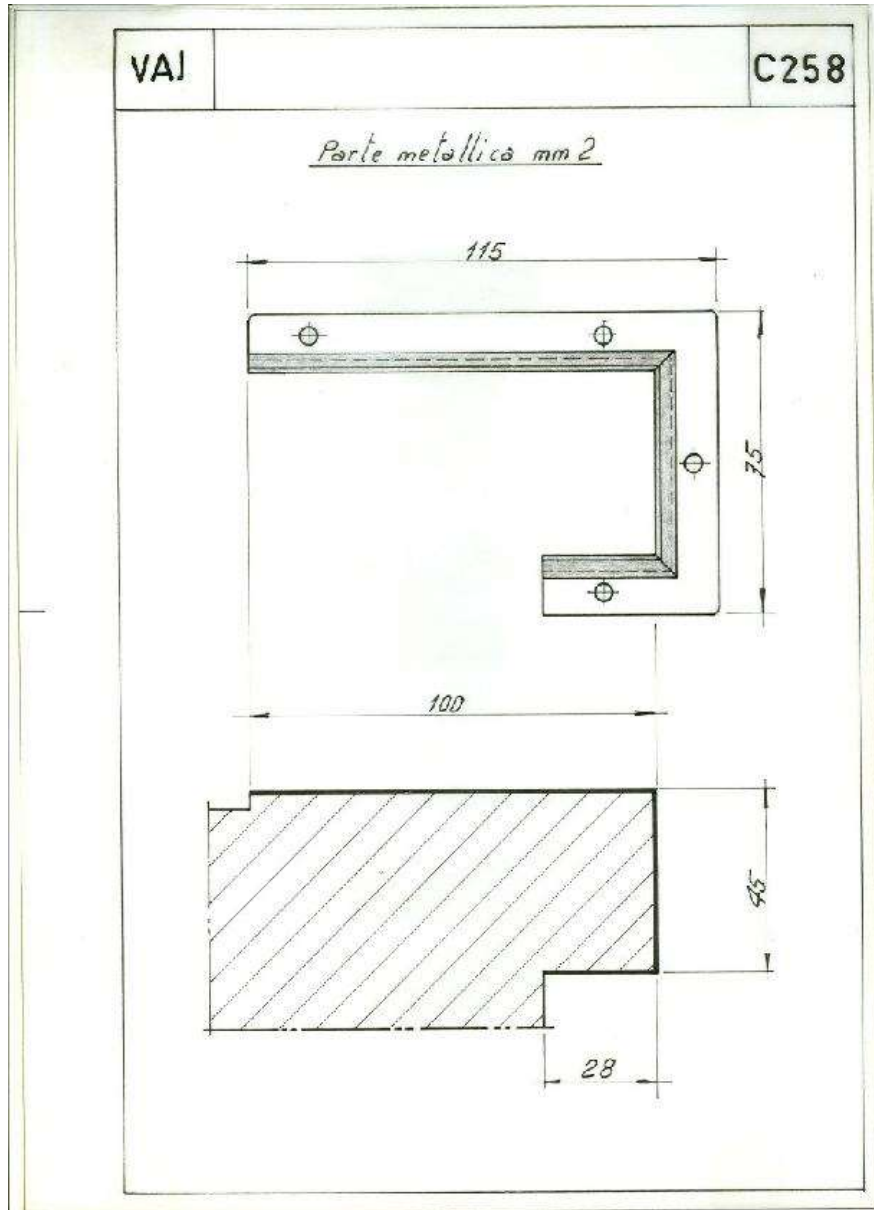

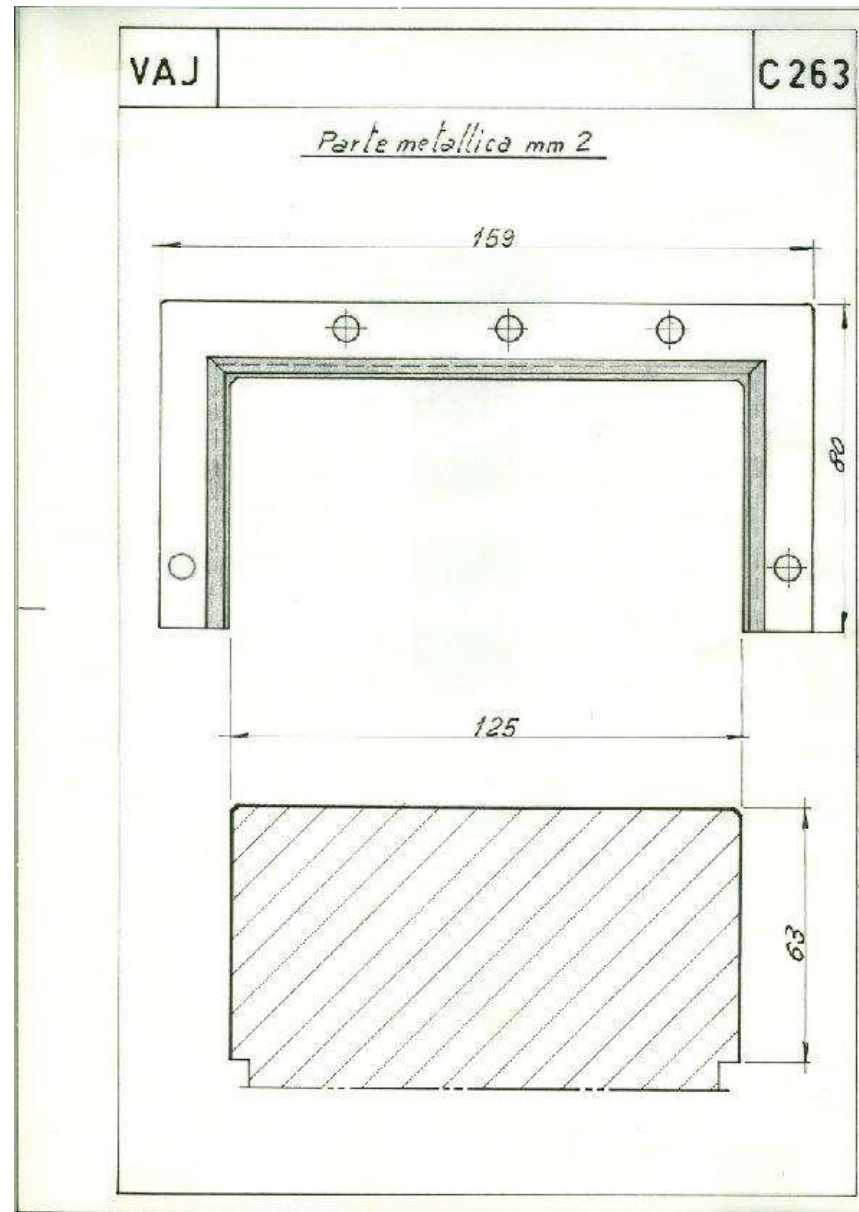
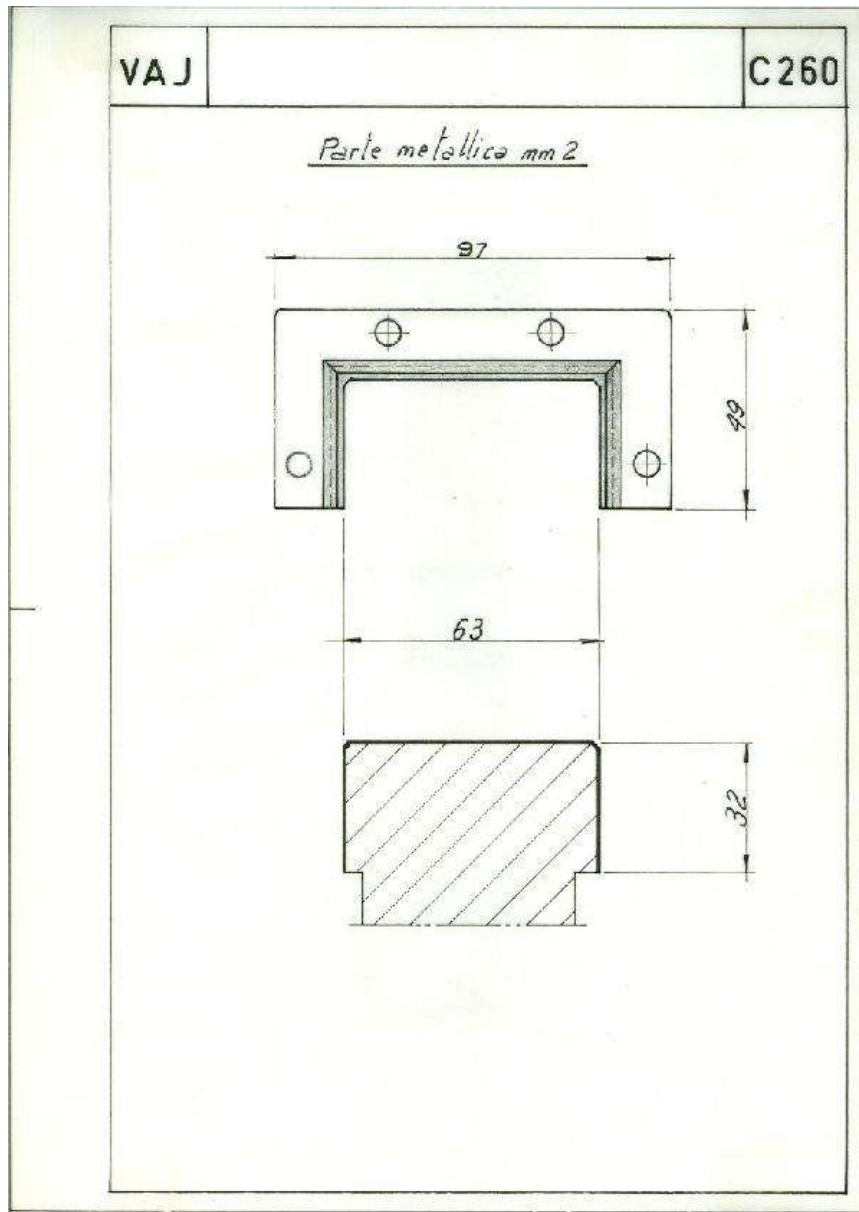

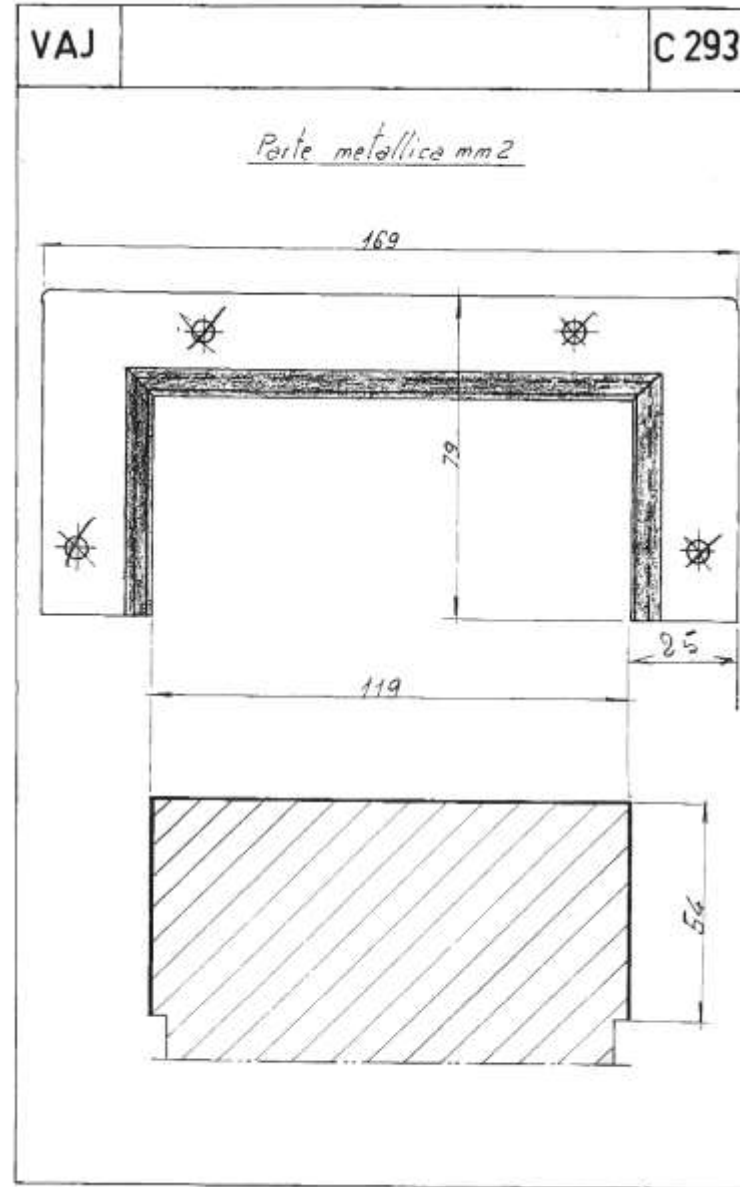
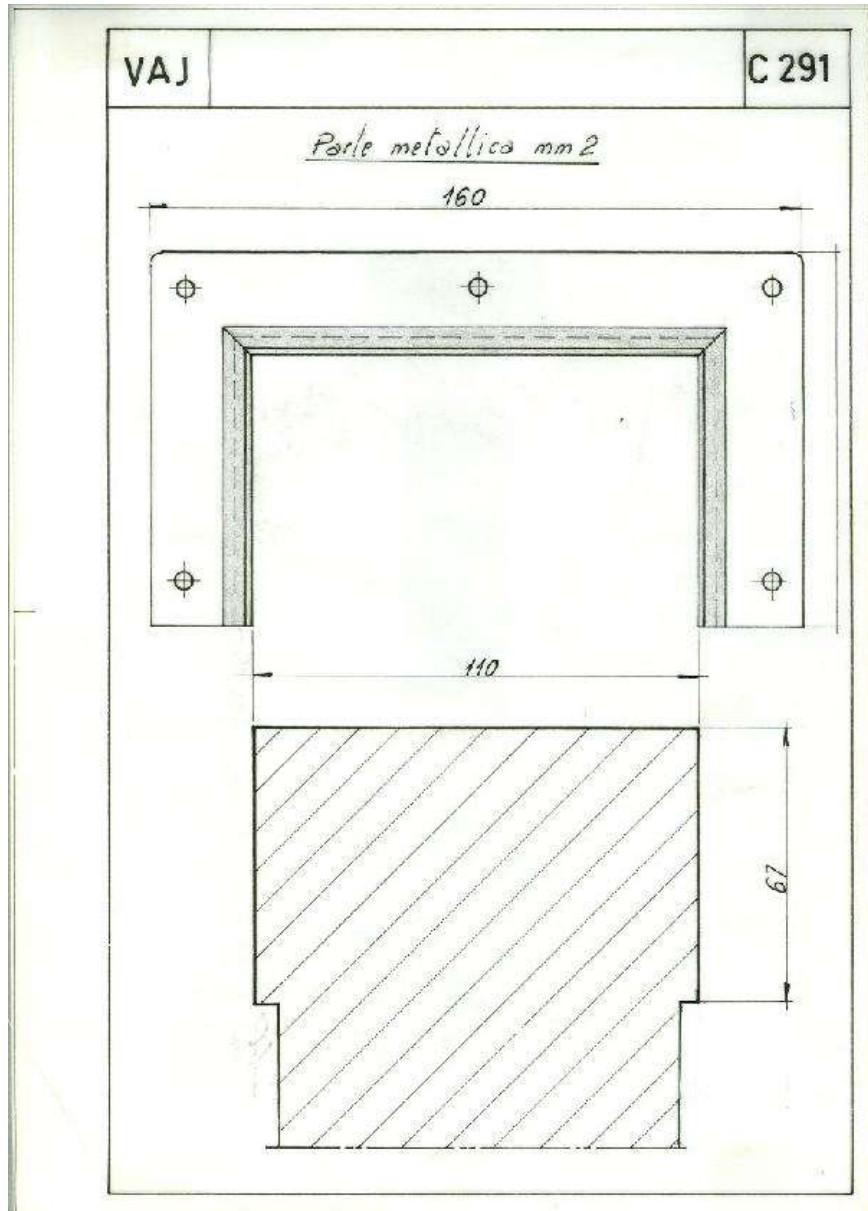

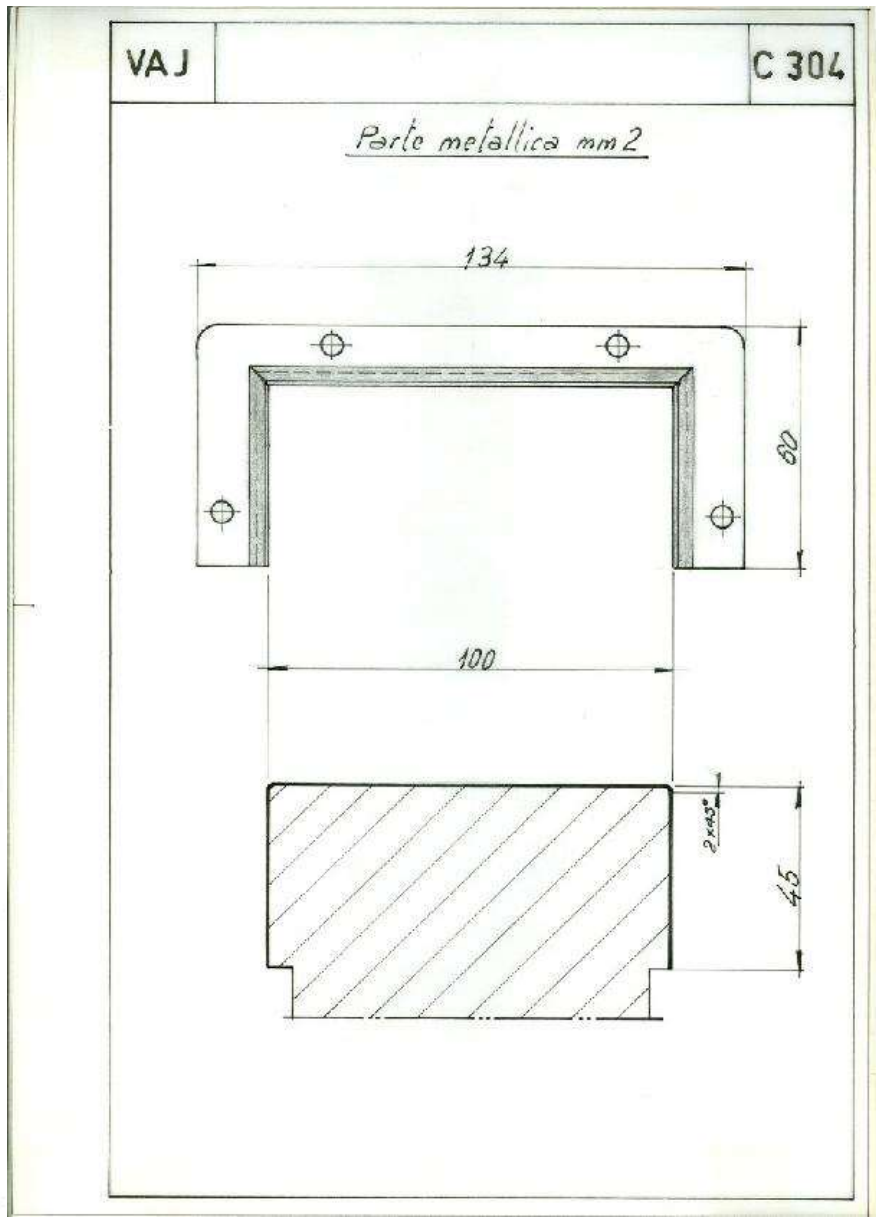
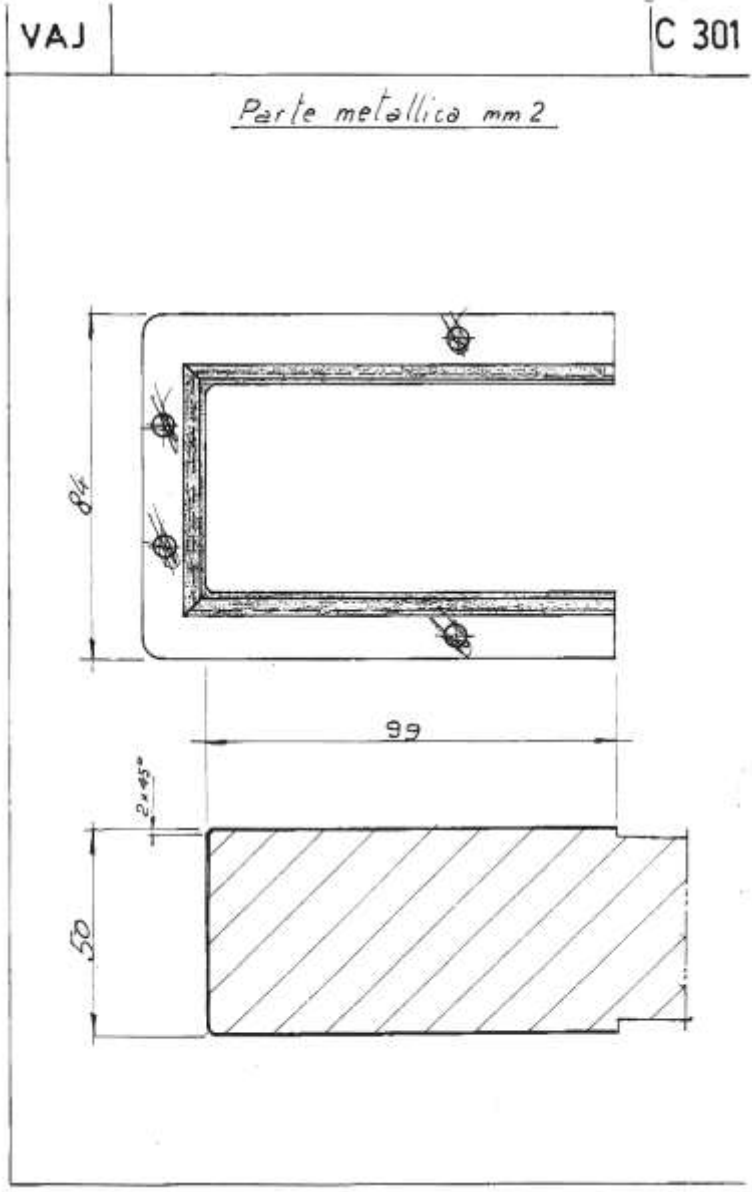

VAJ

C305

Parte metallica mm 2

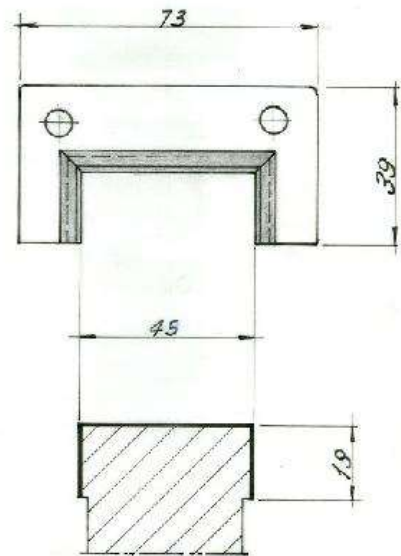

VAJ

C306

Parte metallica mm 2

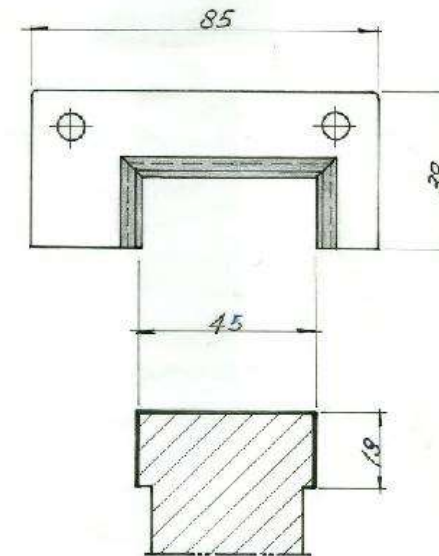

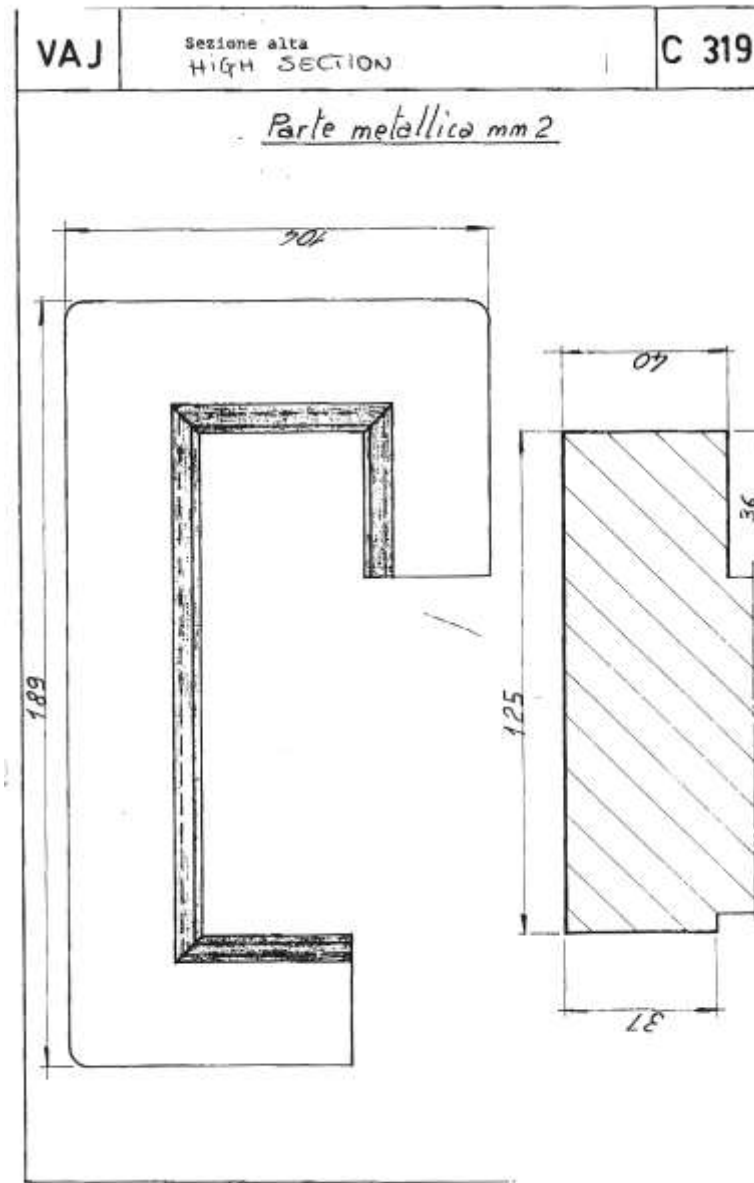
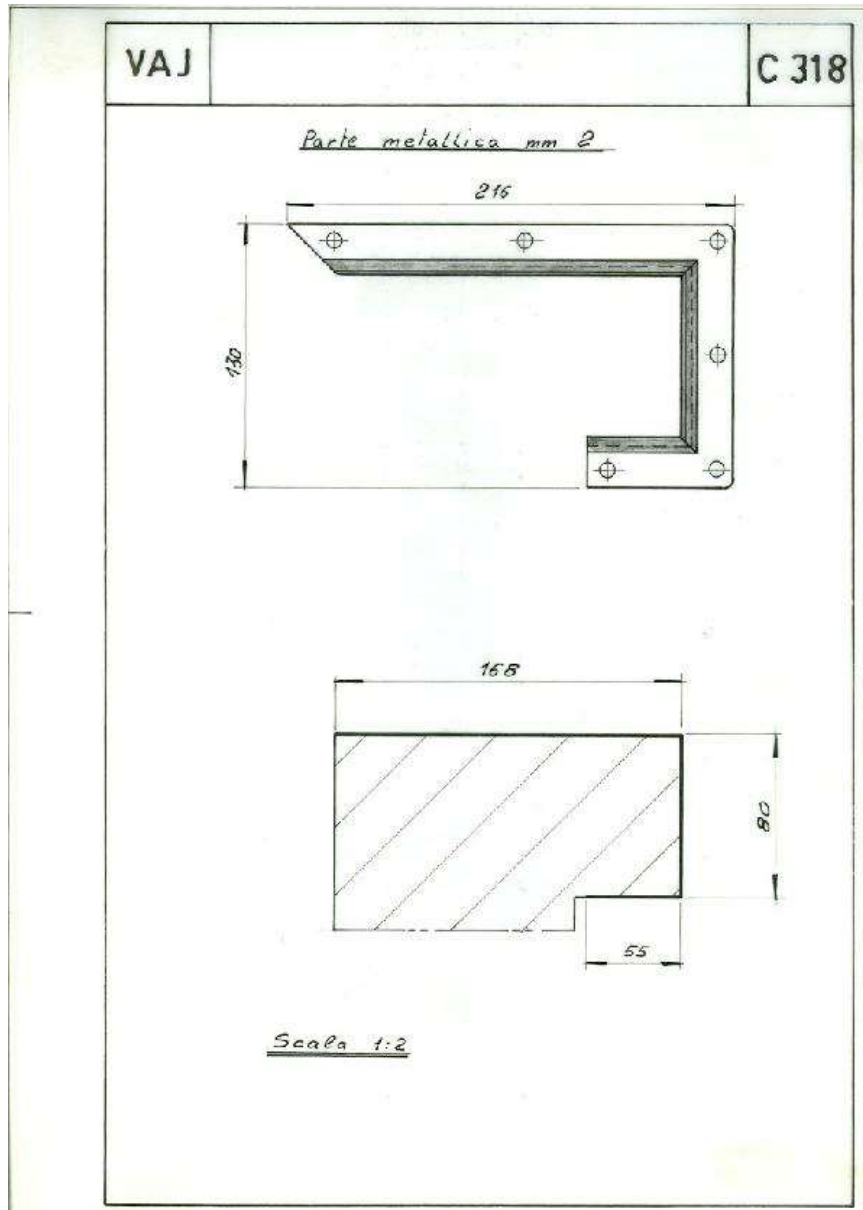

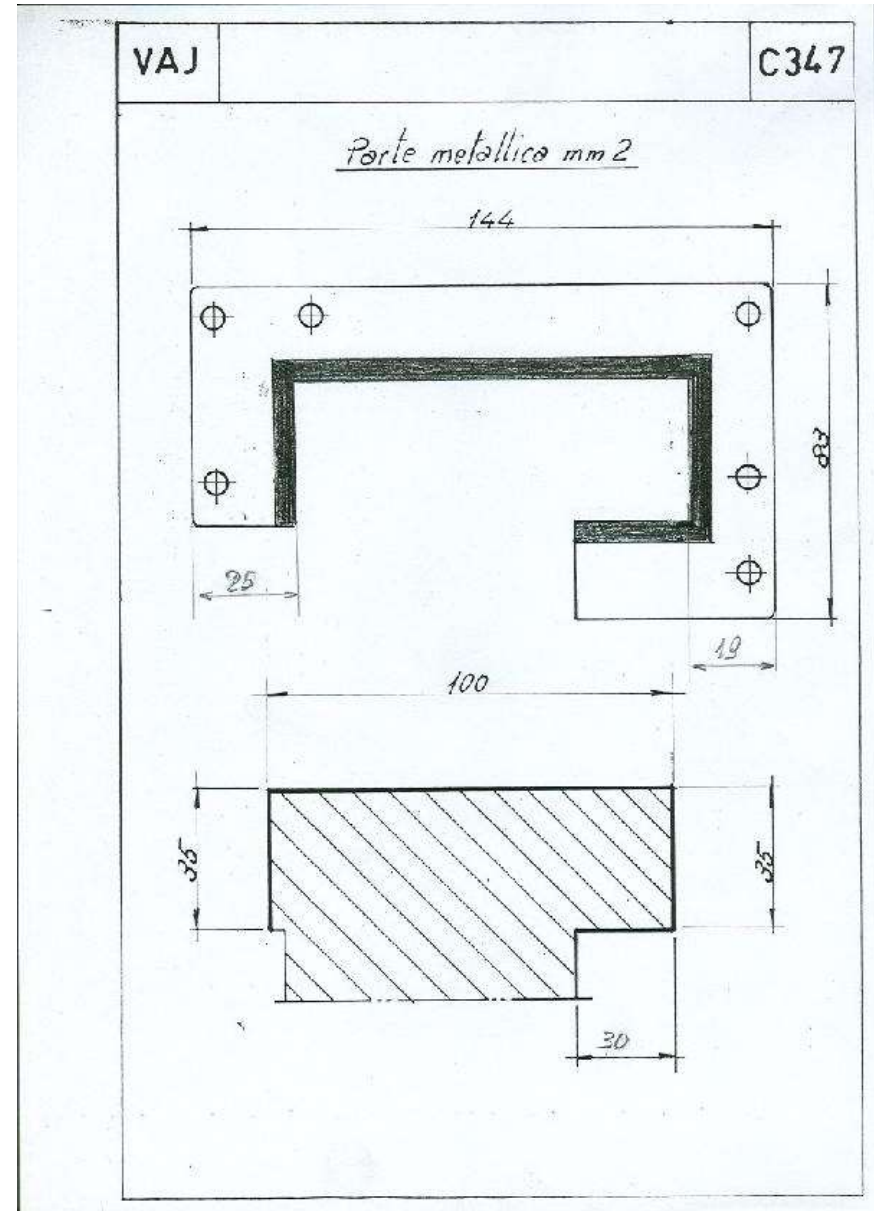
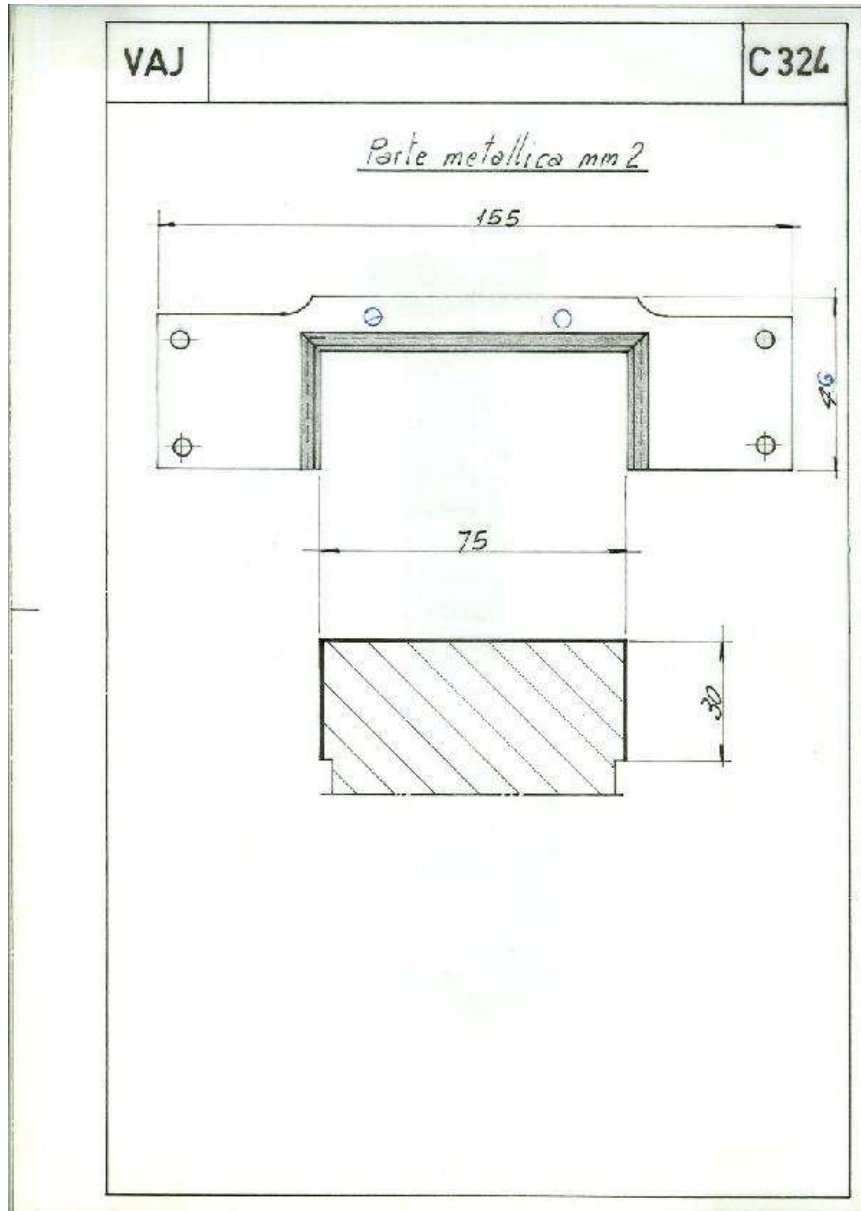

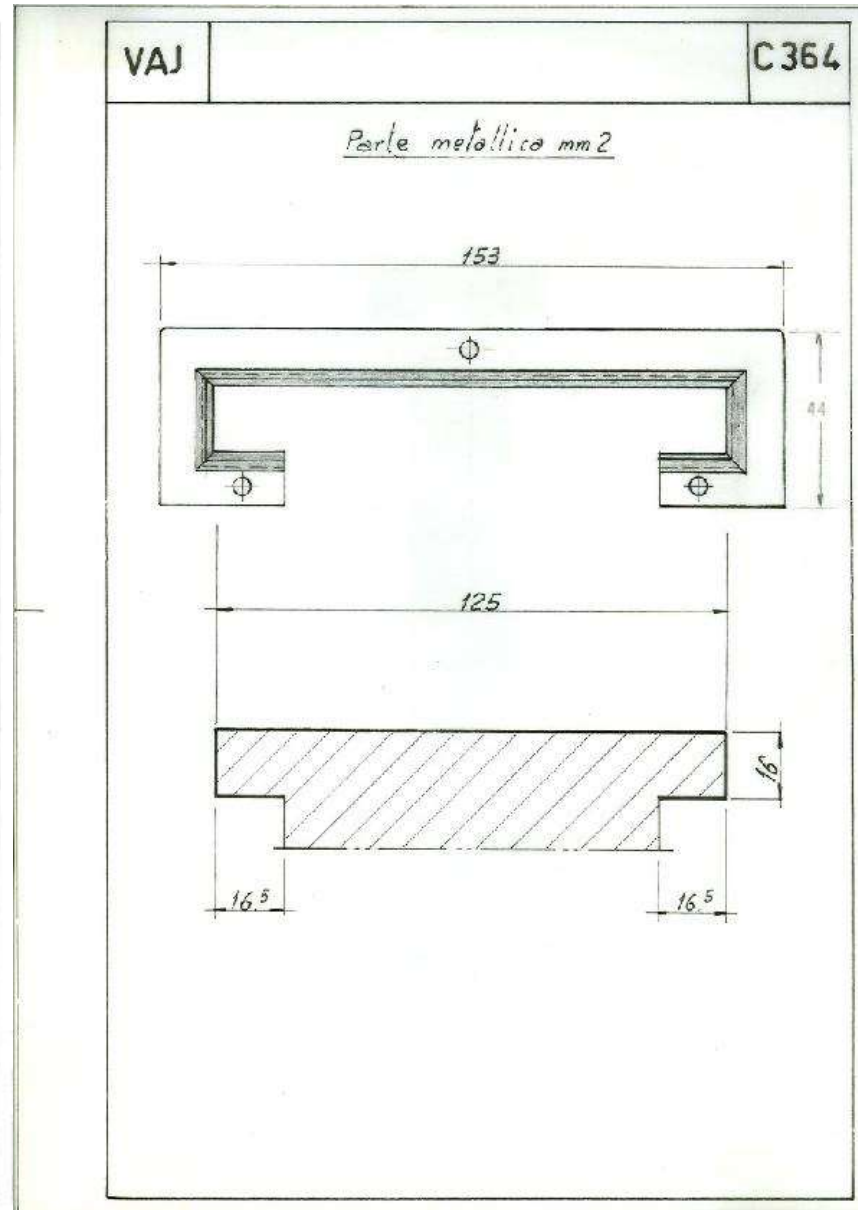
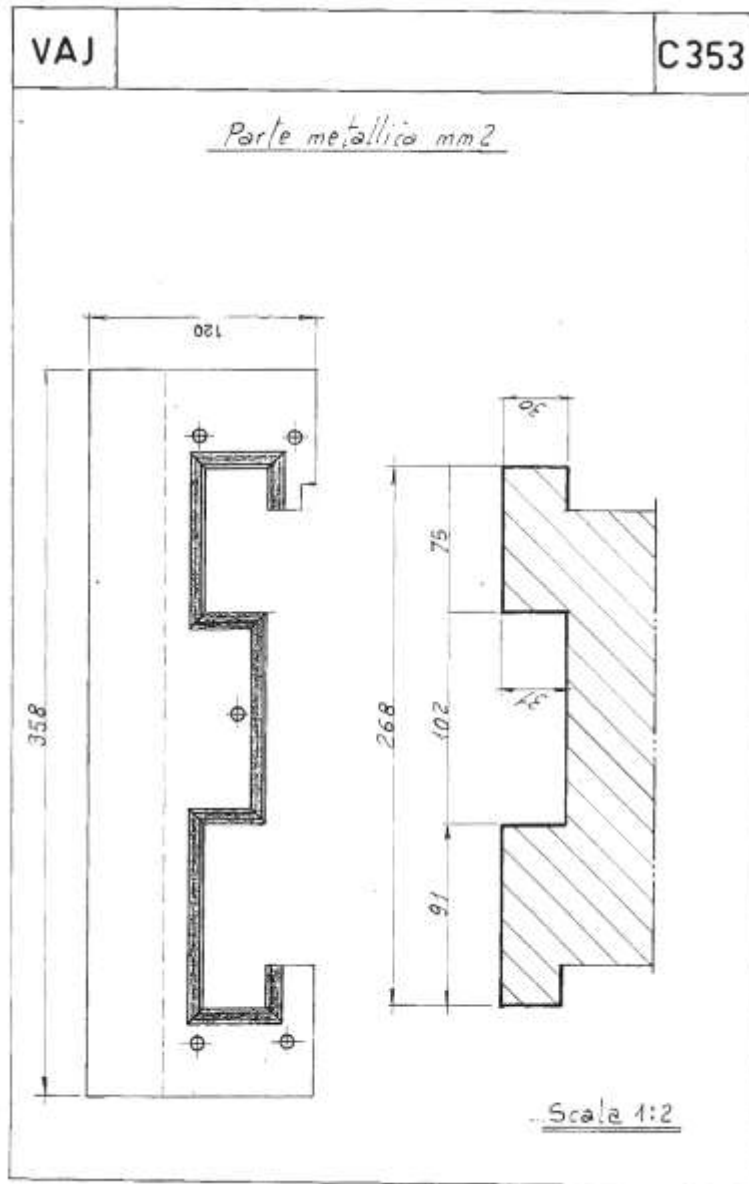

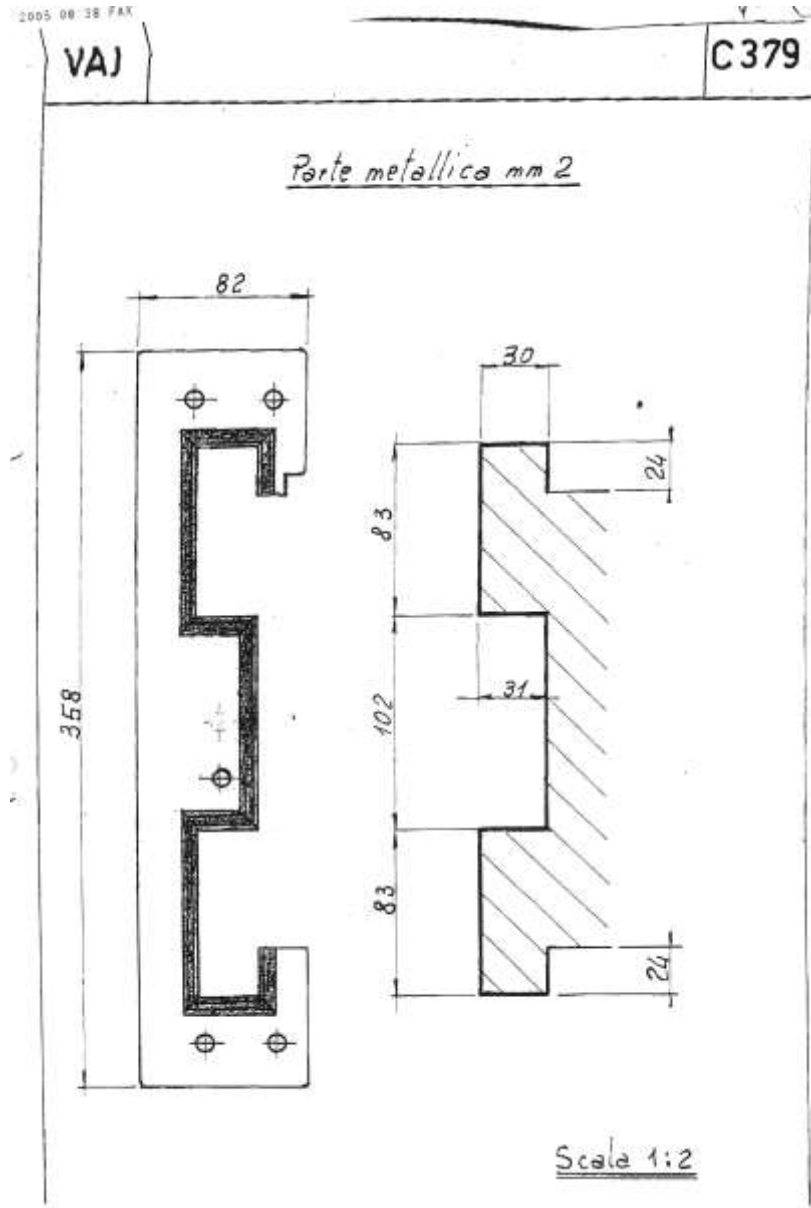
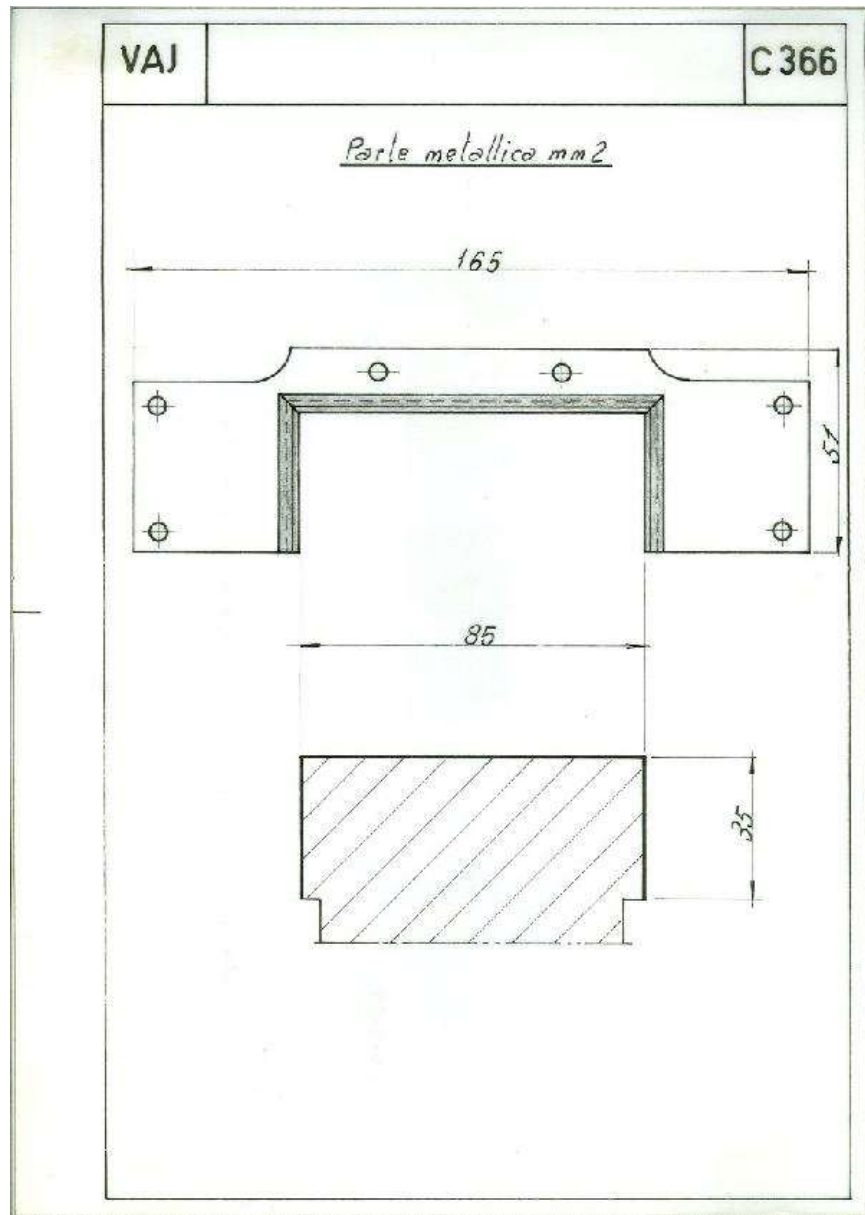

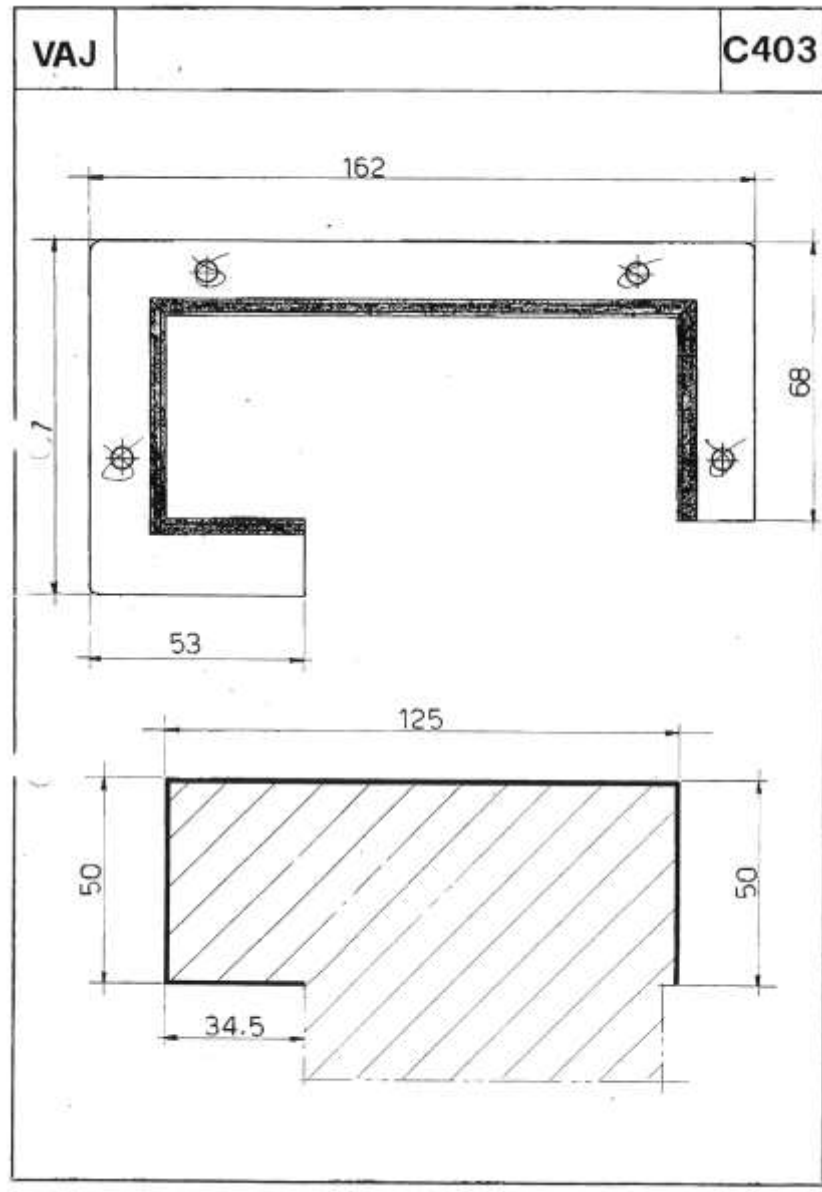
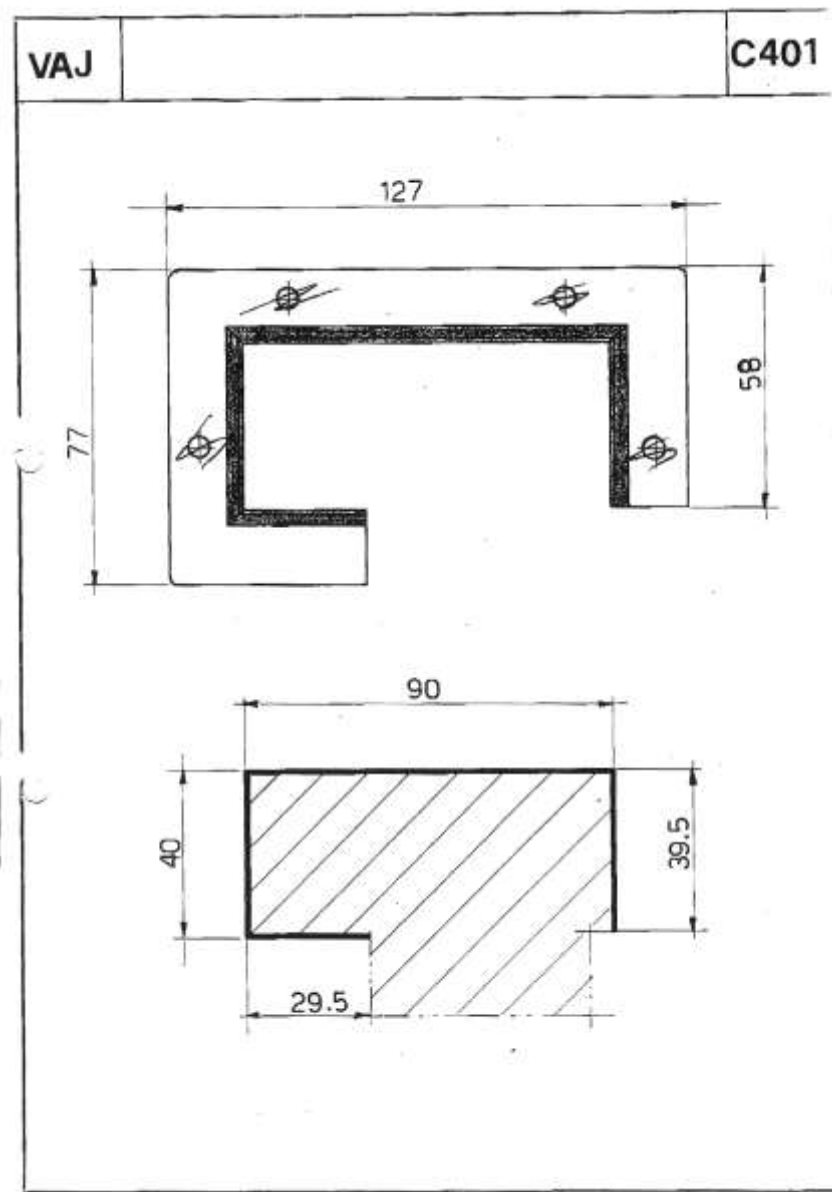

VAJ C437

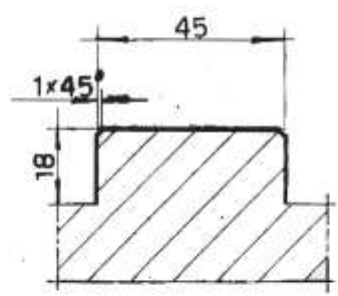
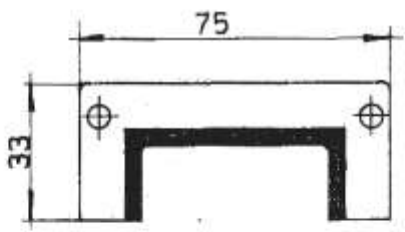

VAJ C438

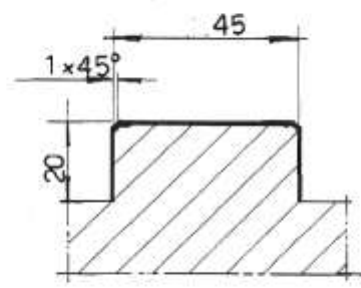
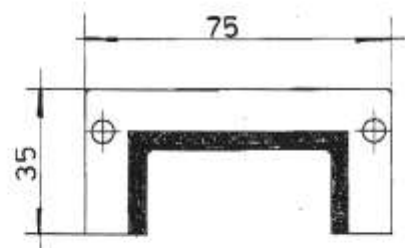

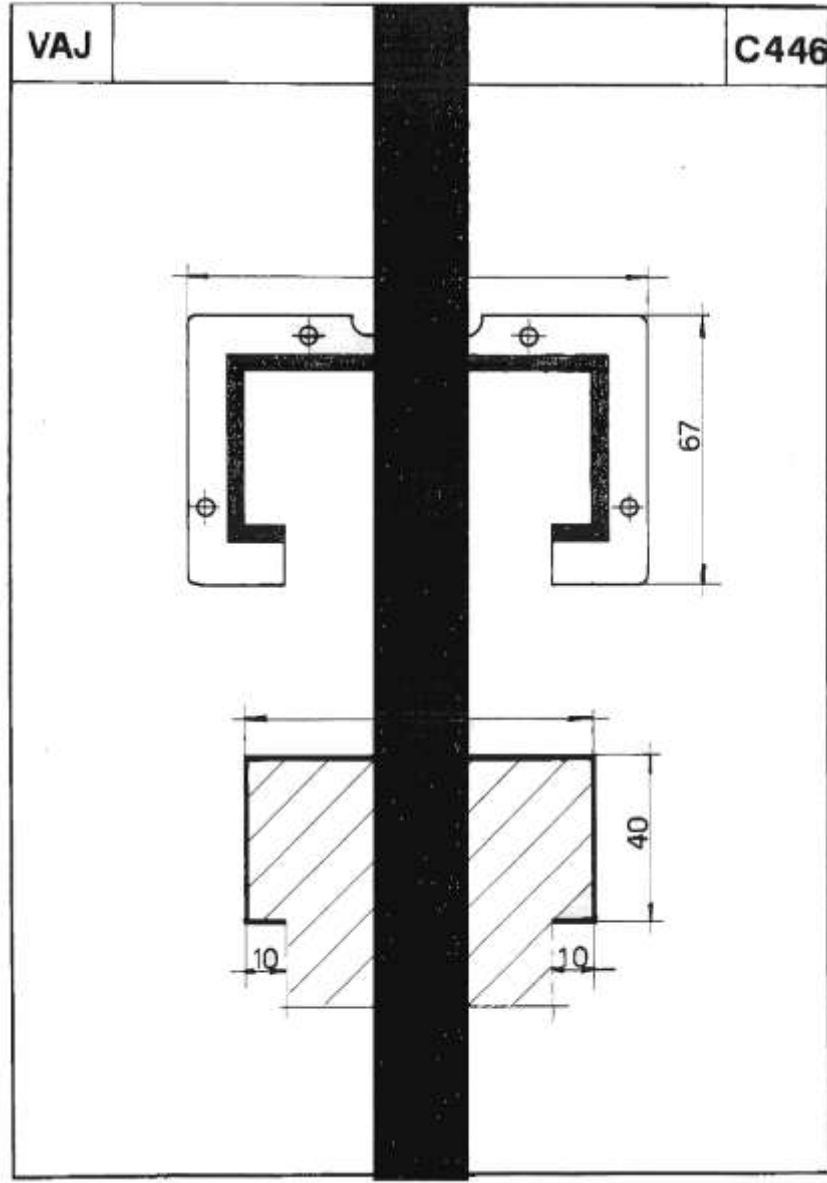
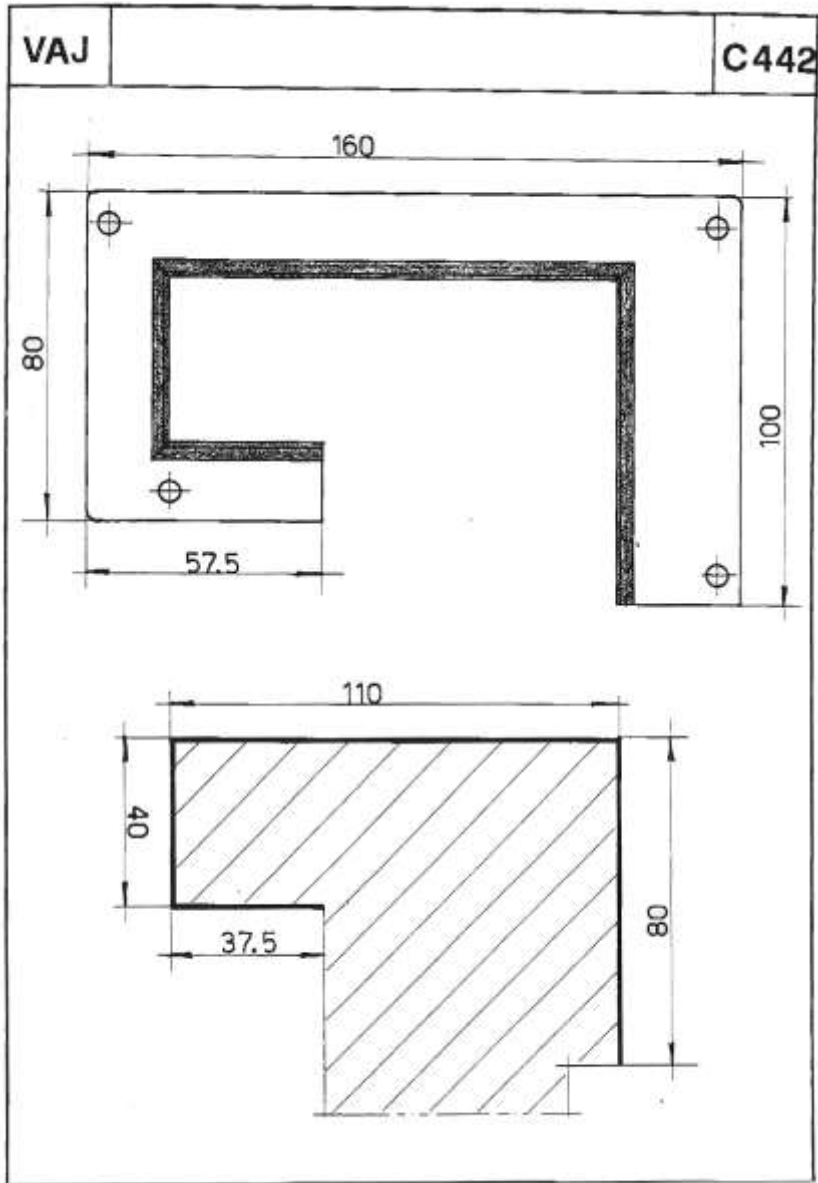

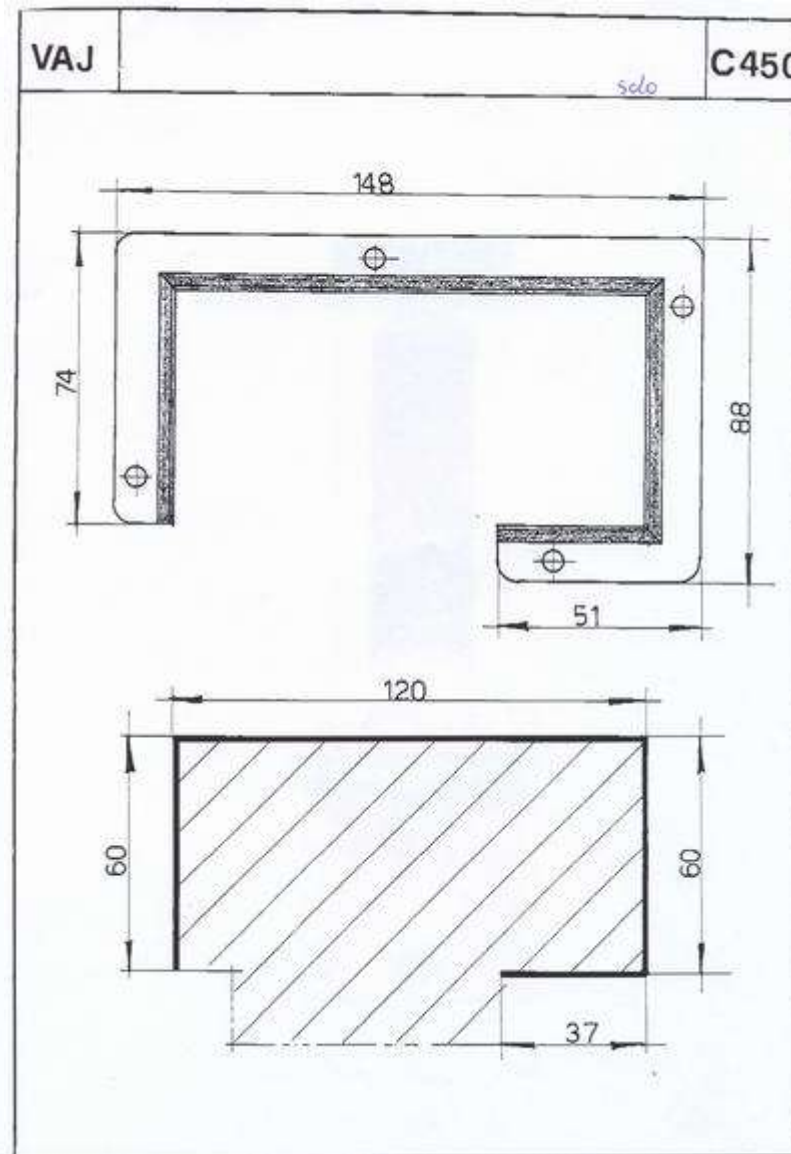
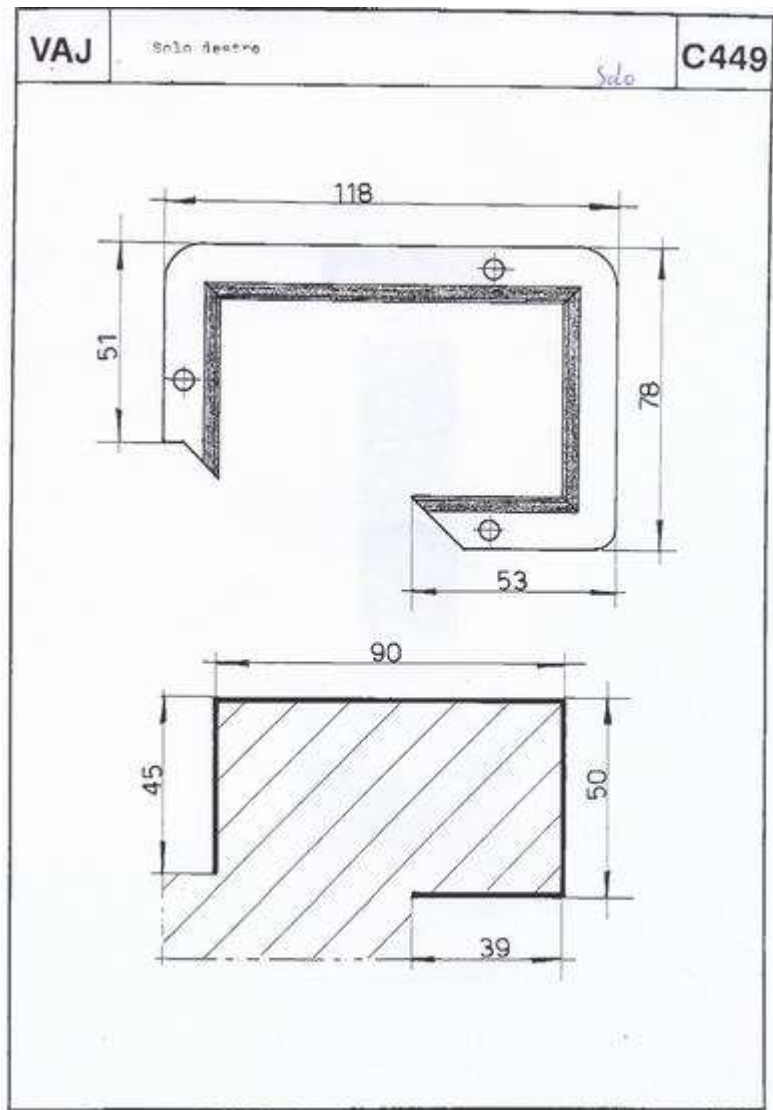

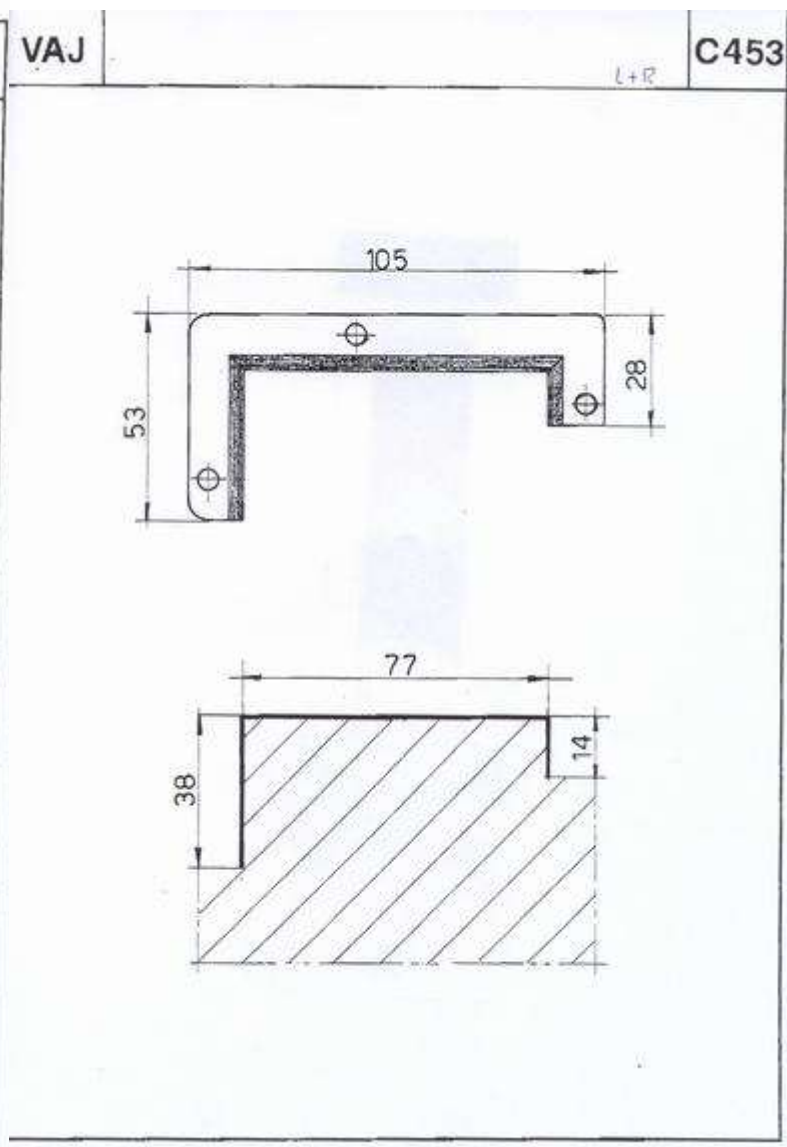
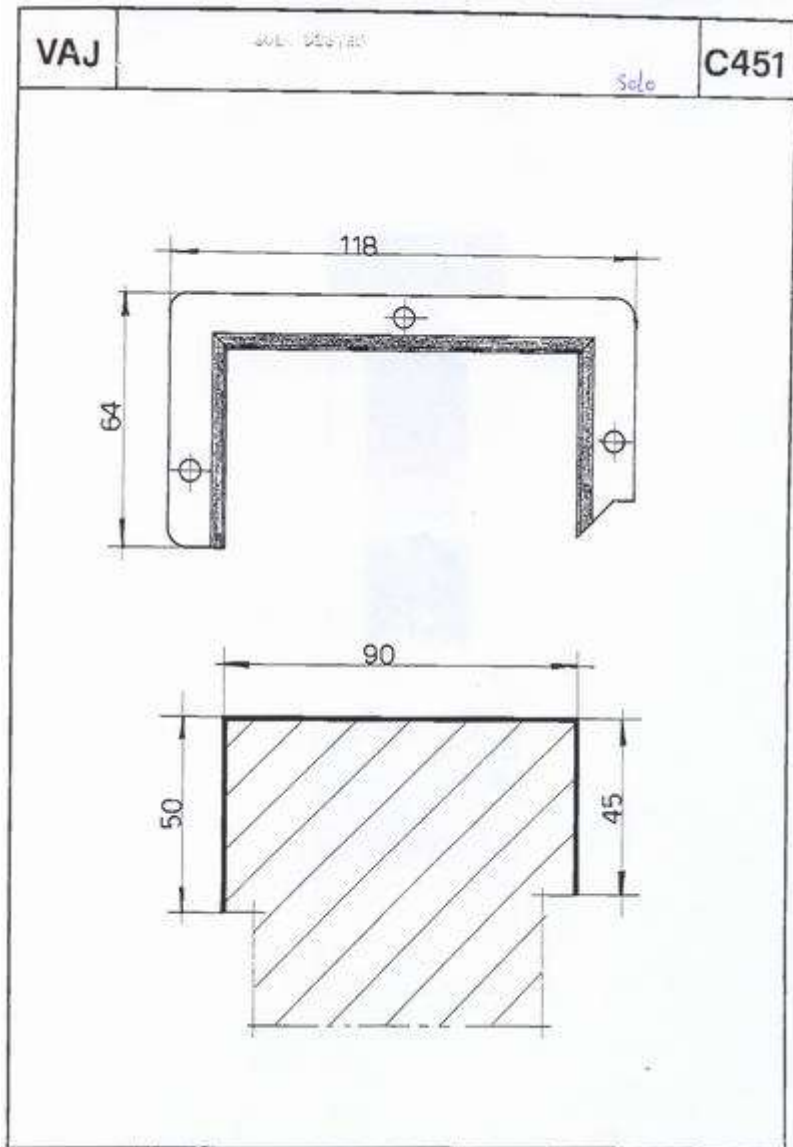

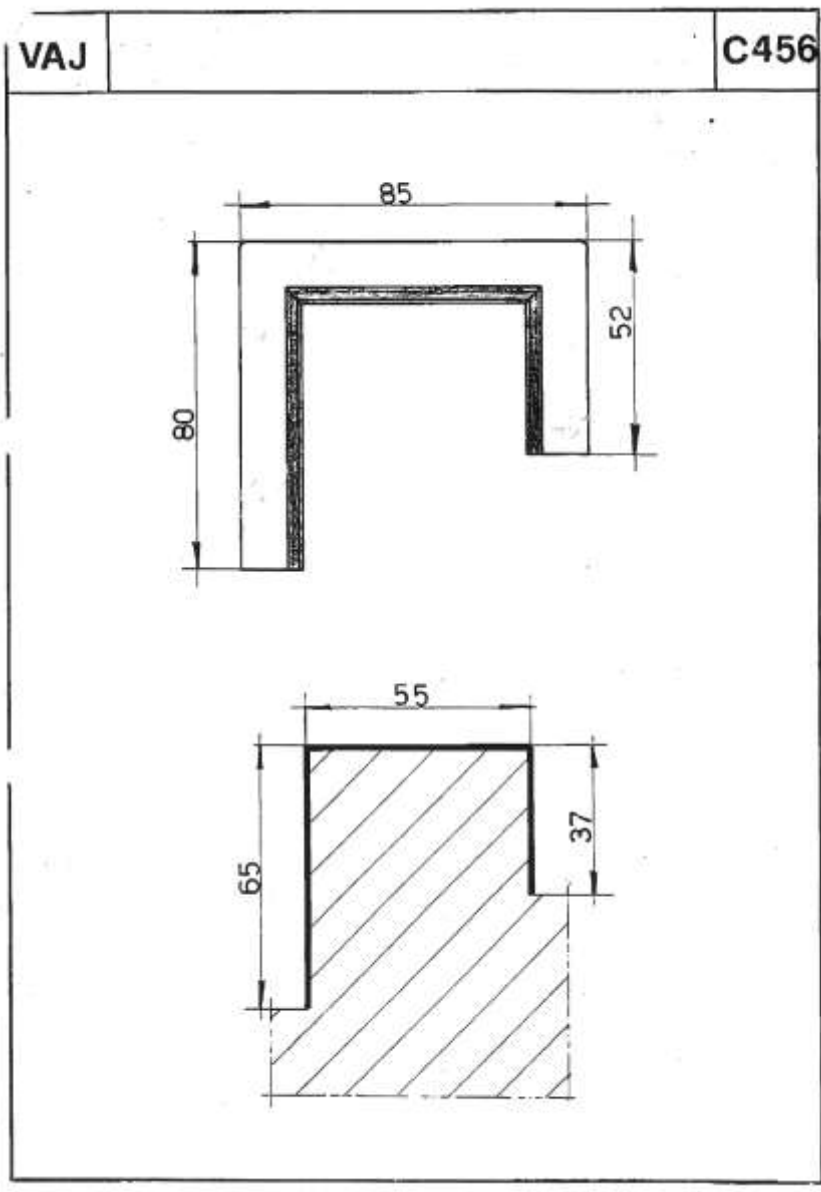
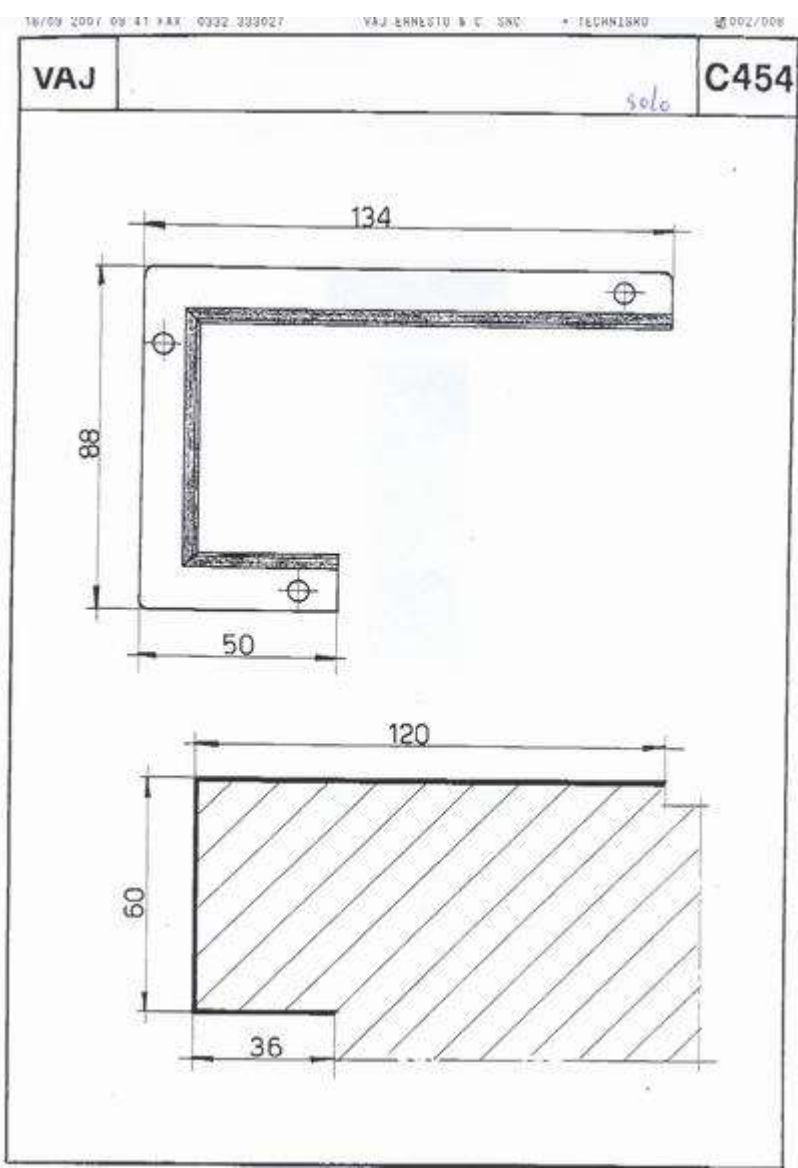

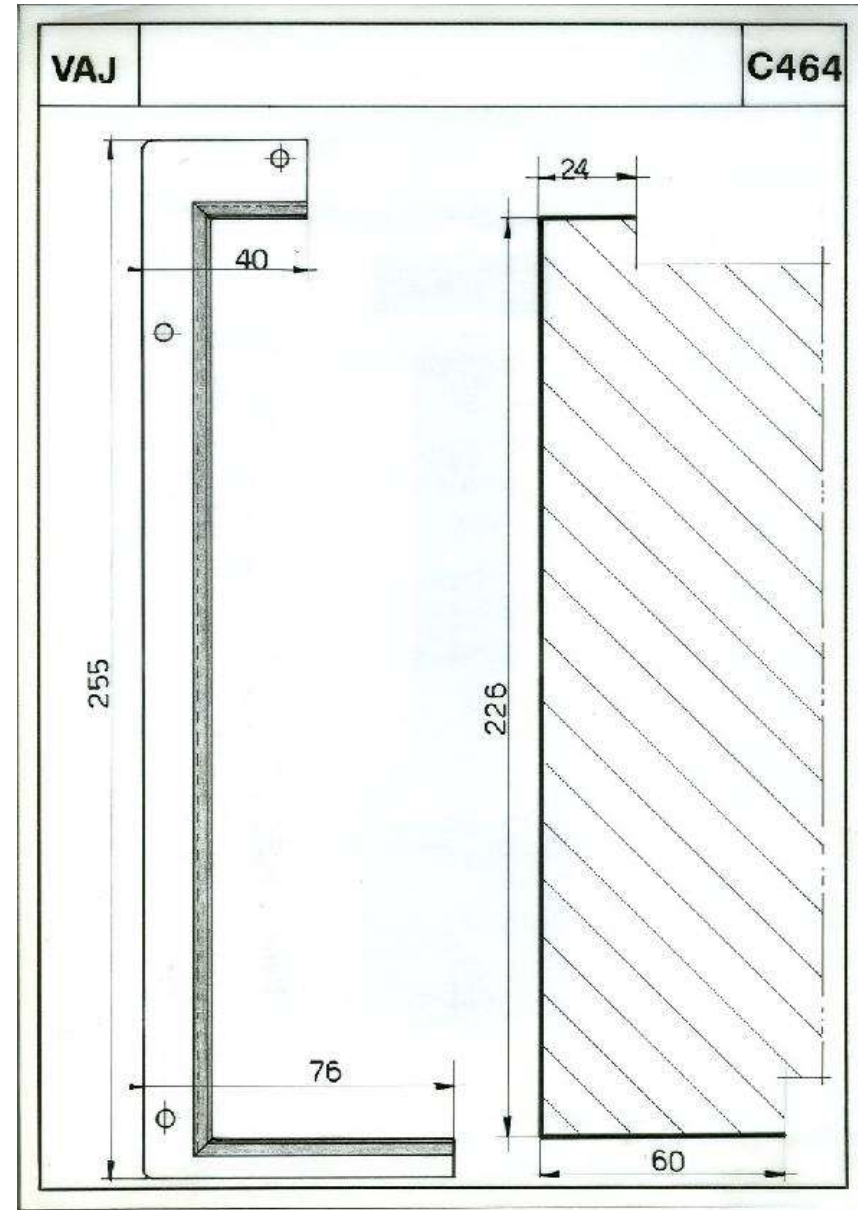
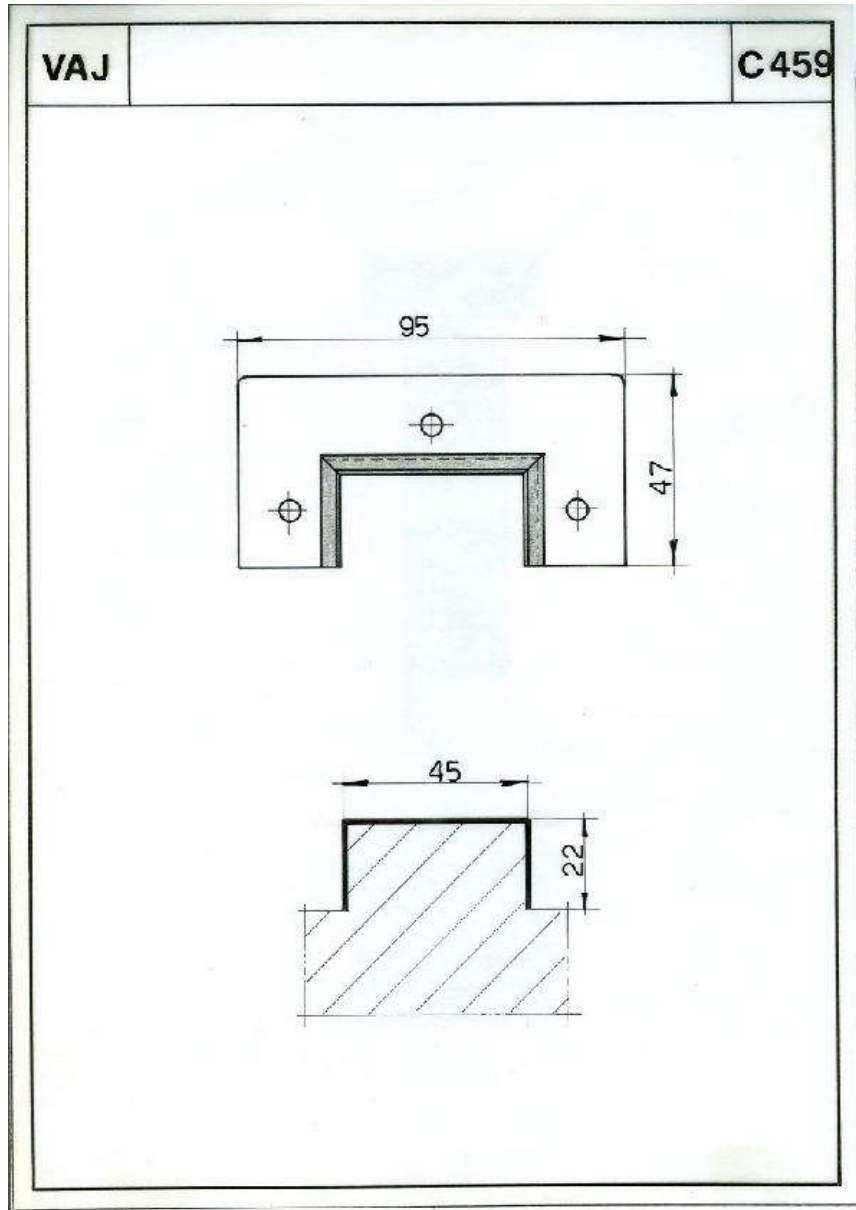

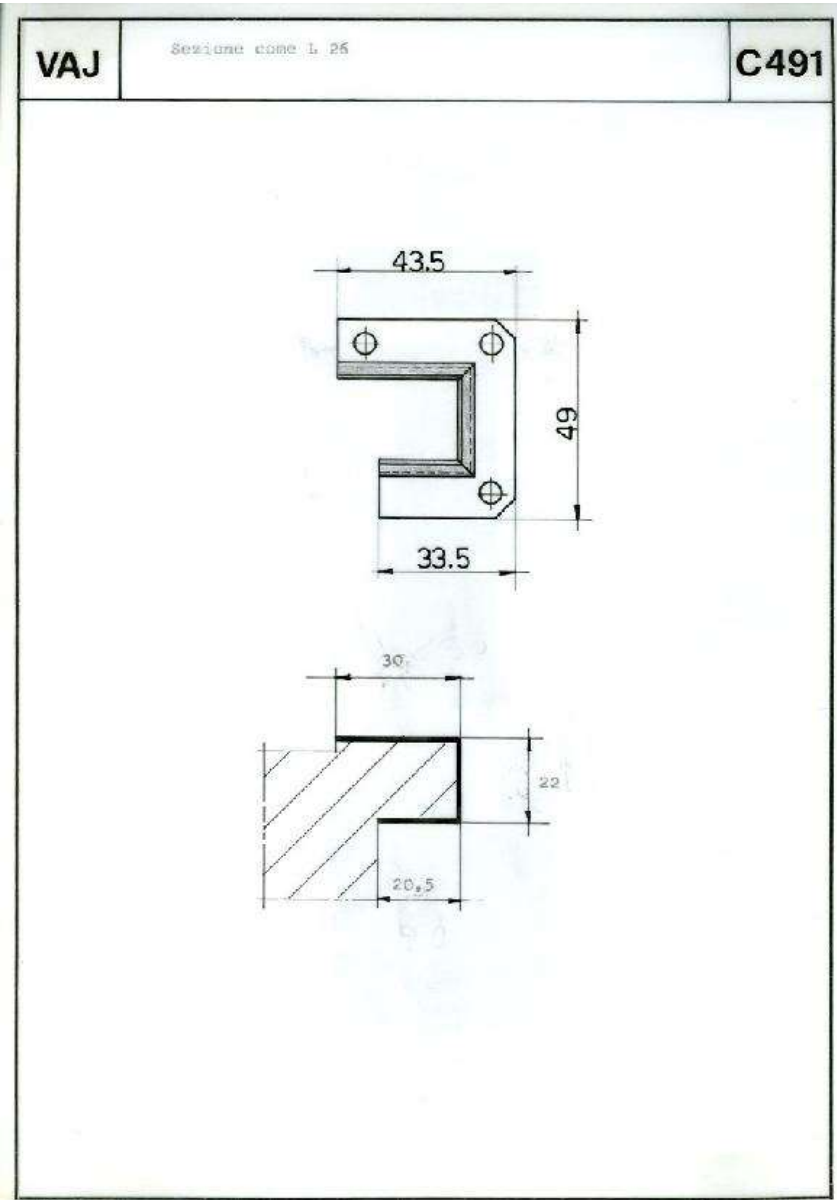
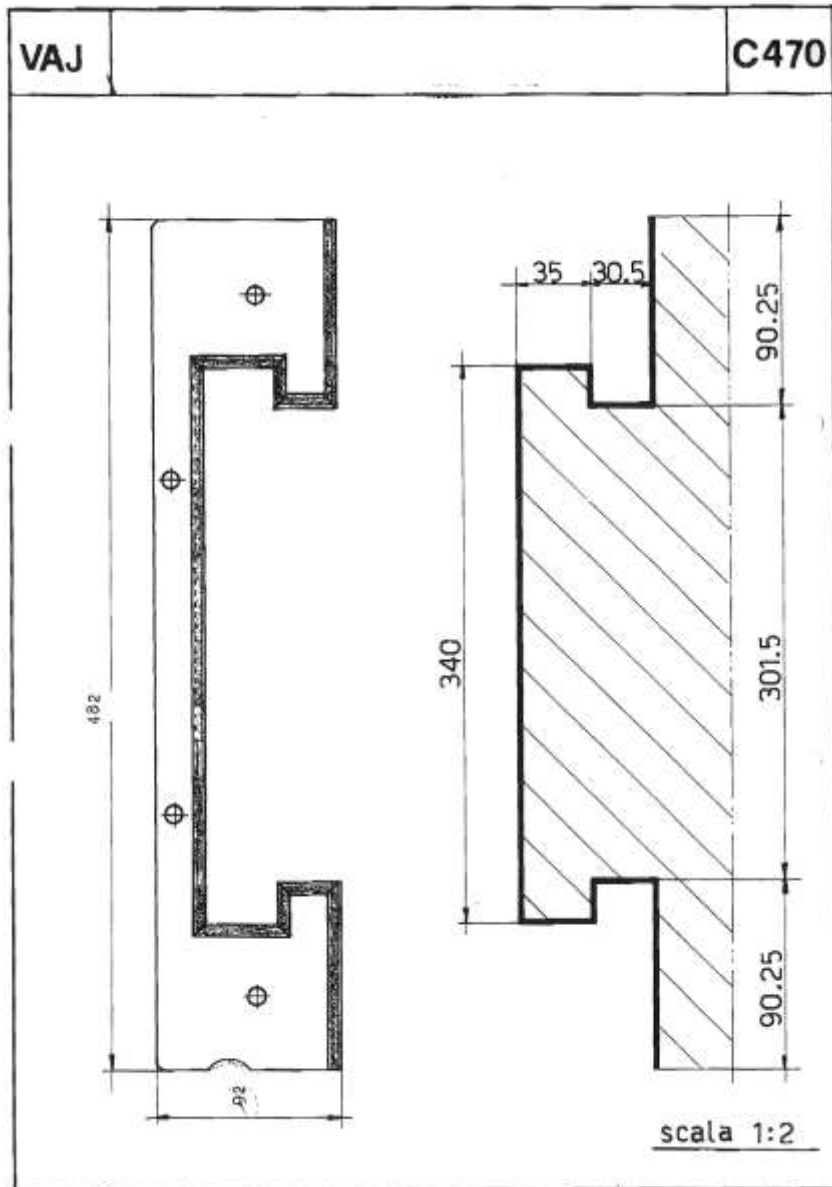

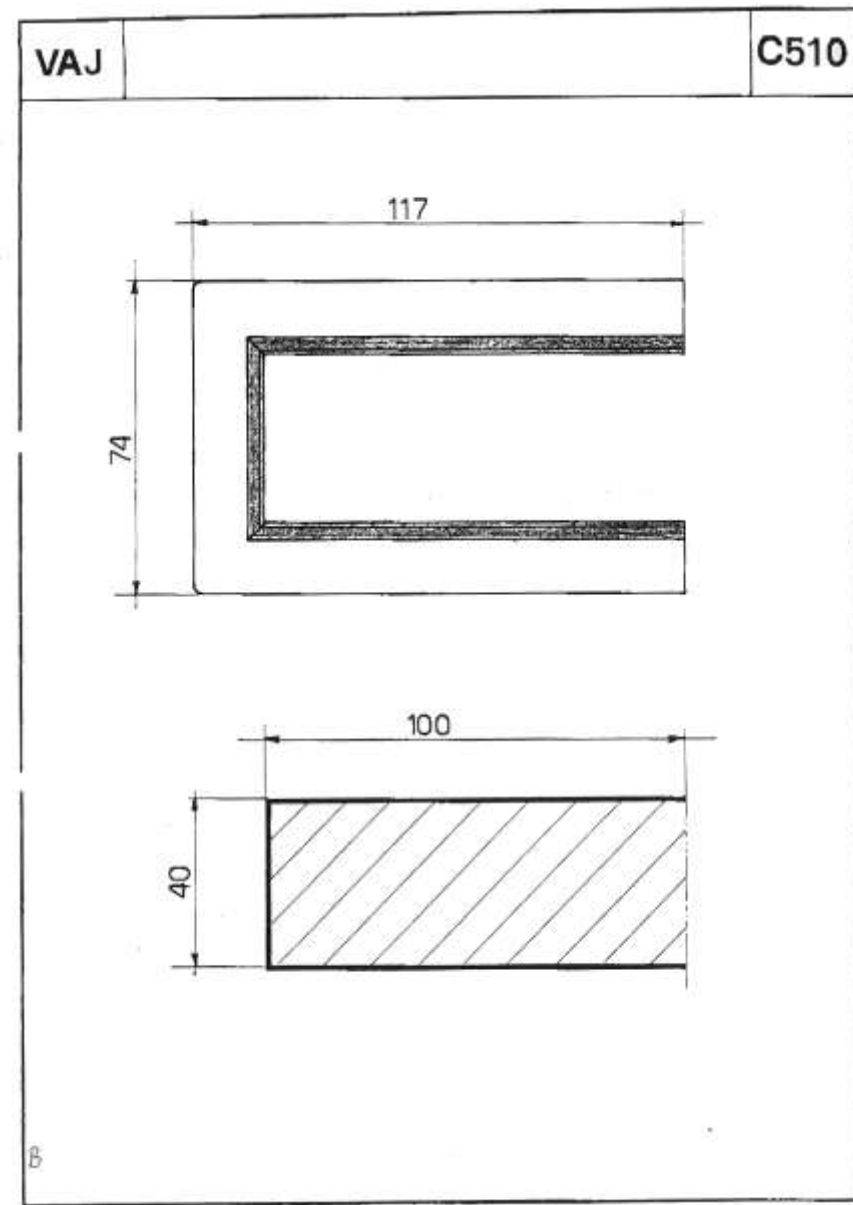
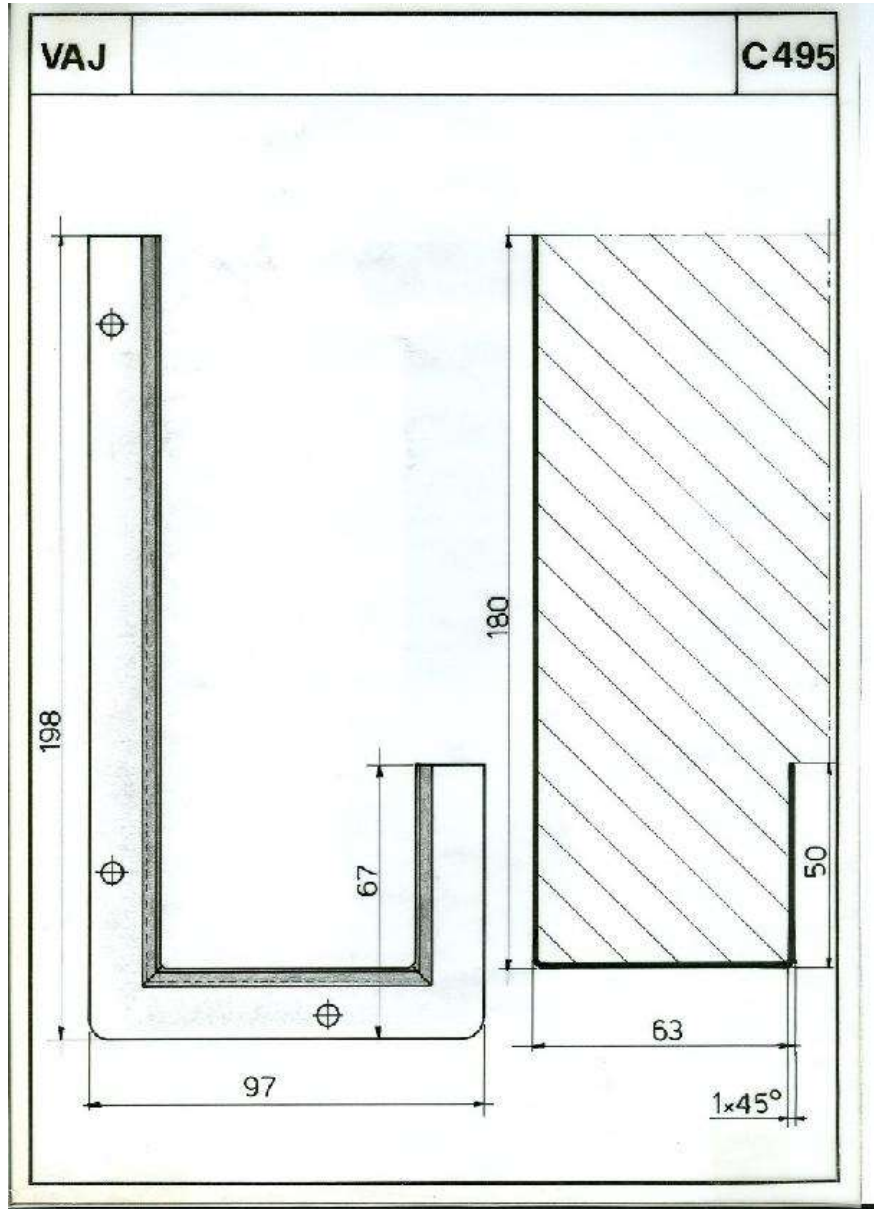

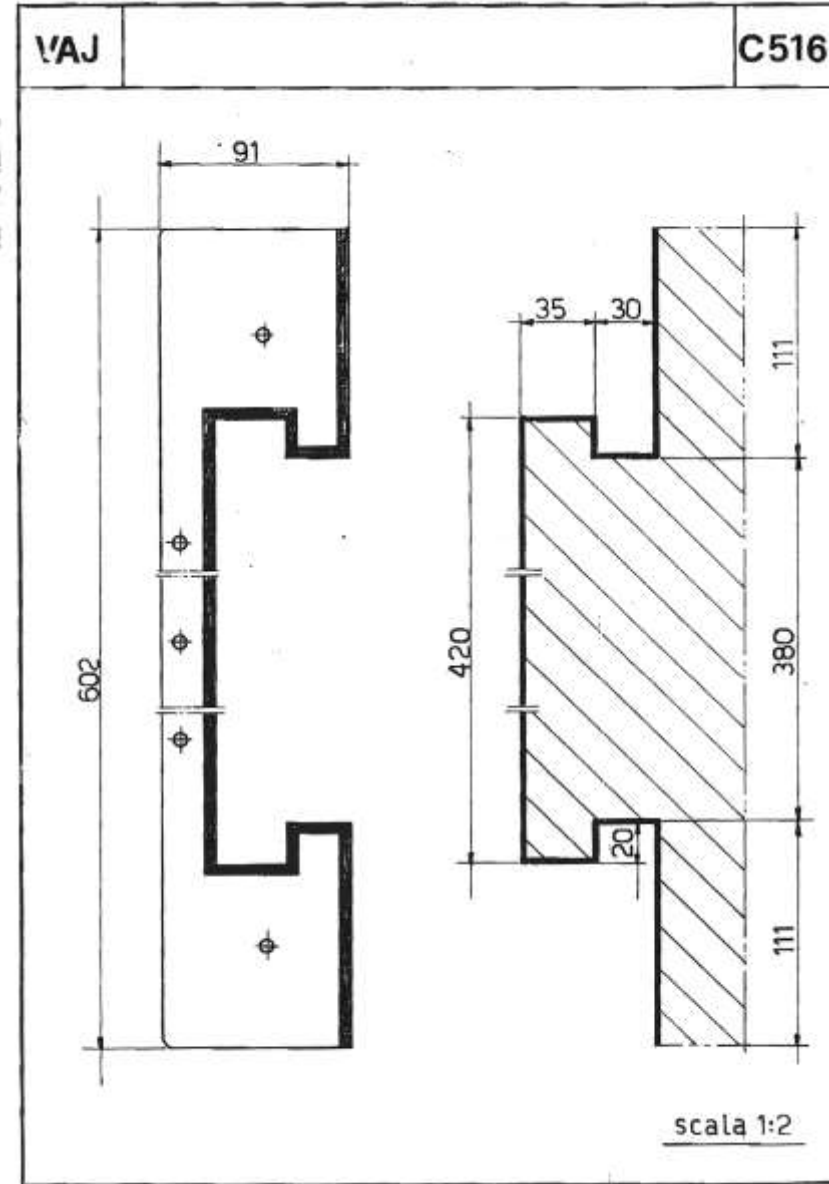
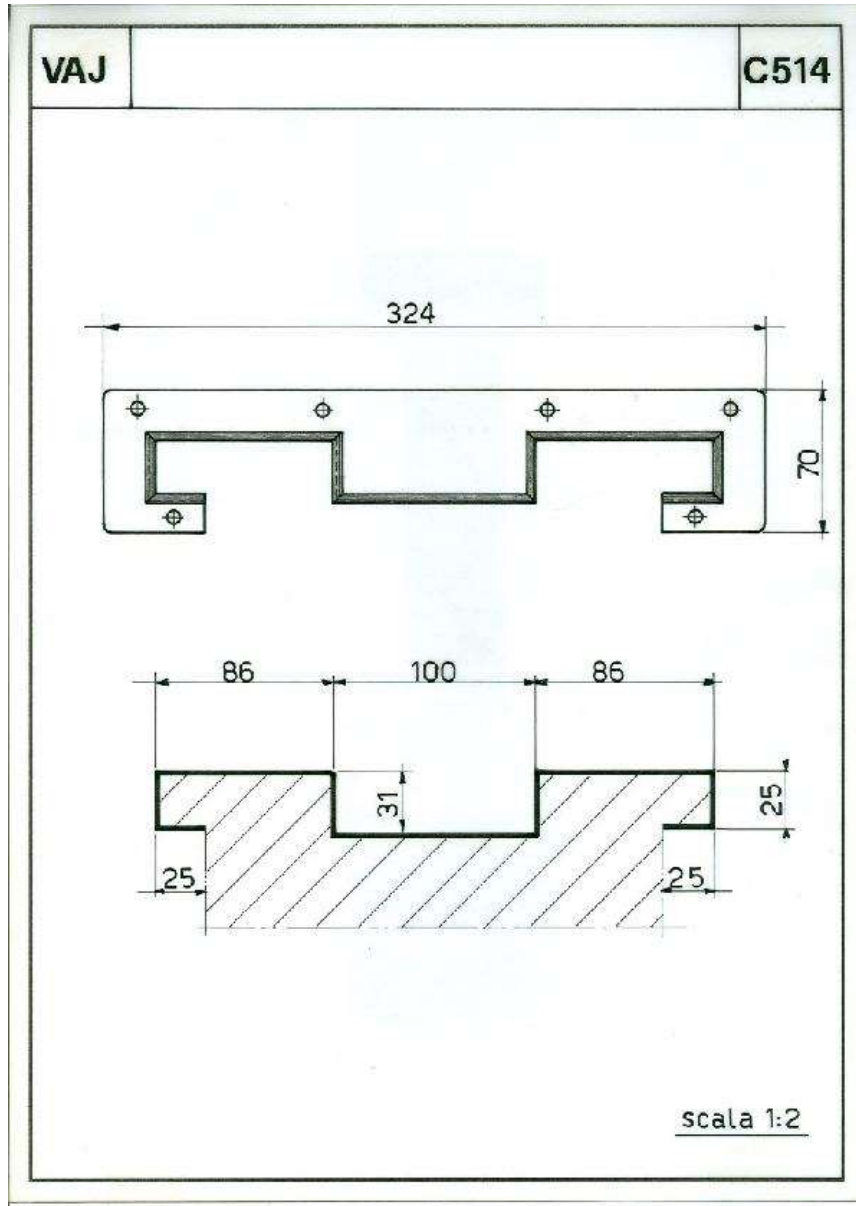

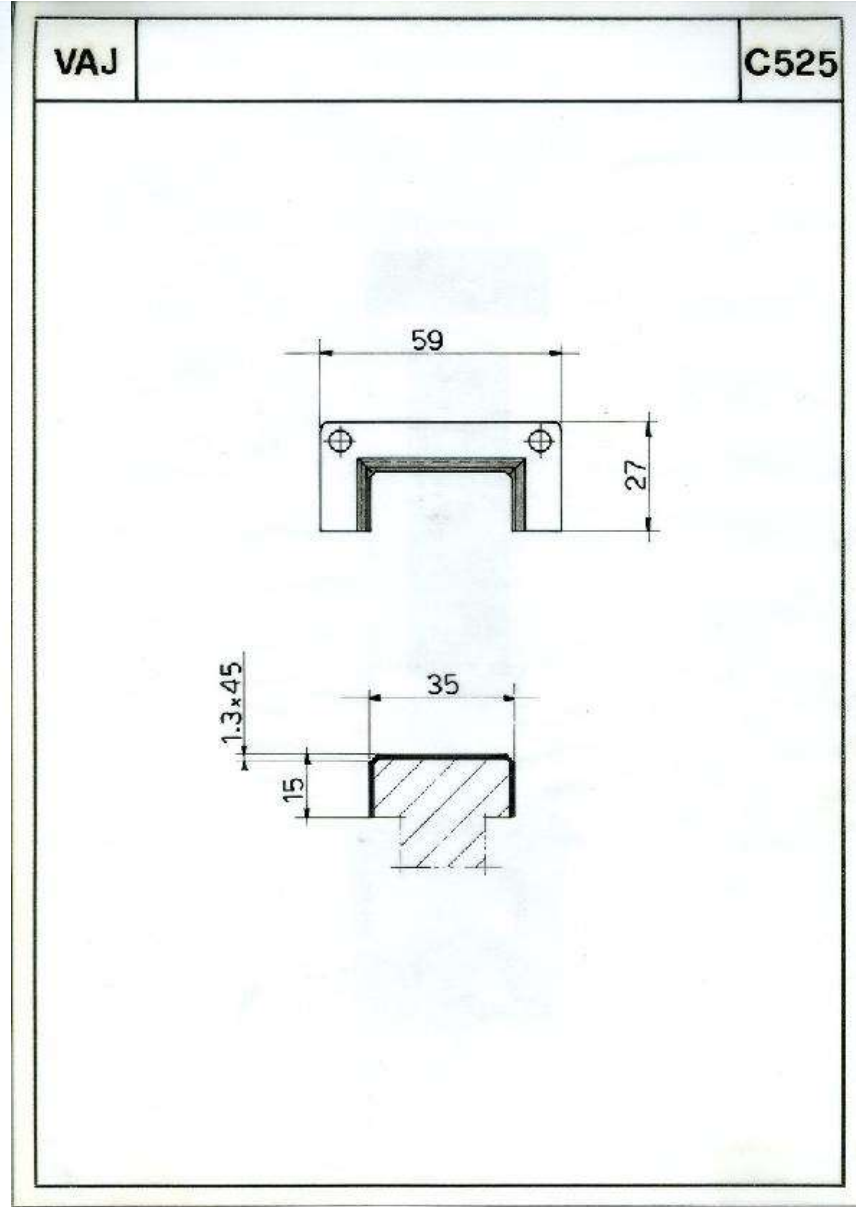
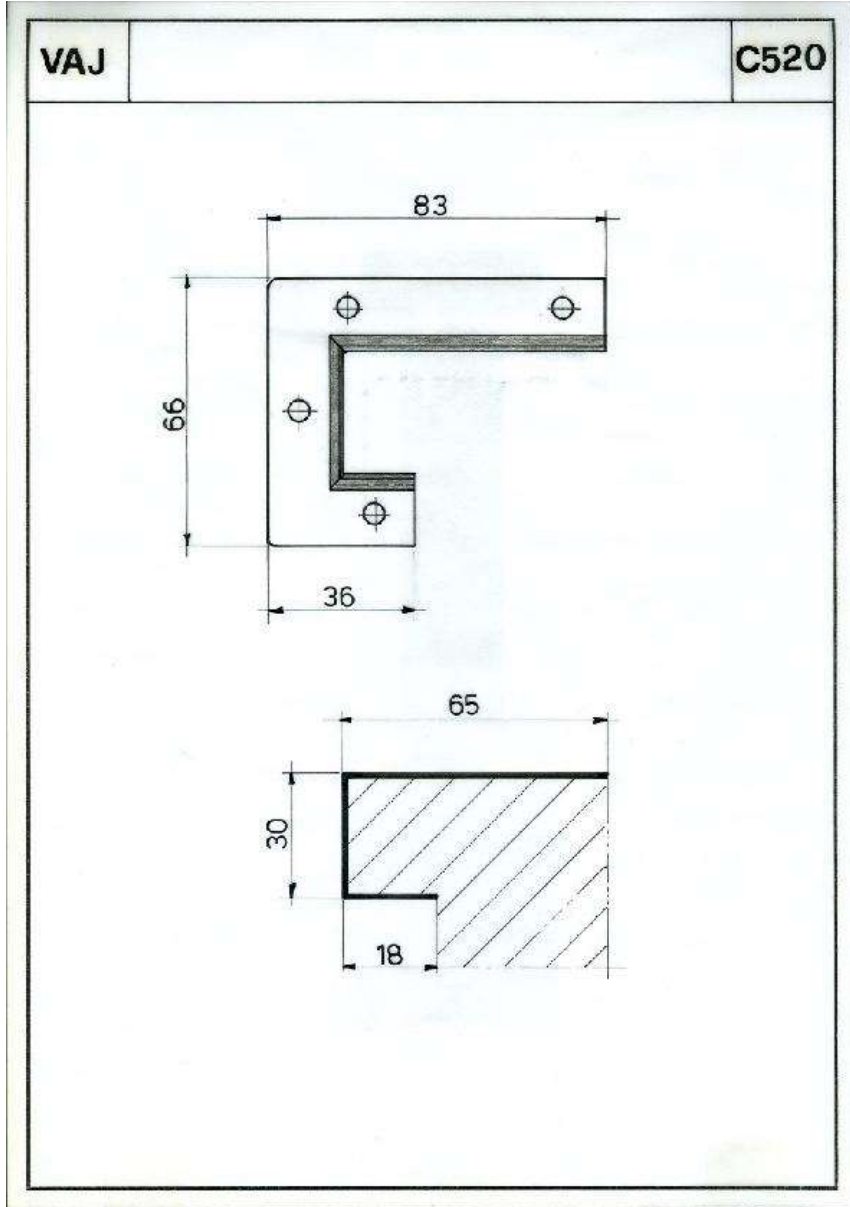

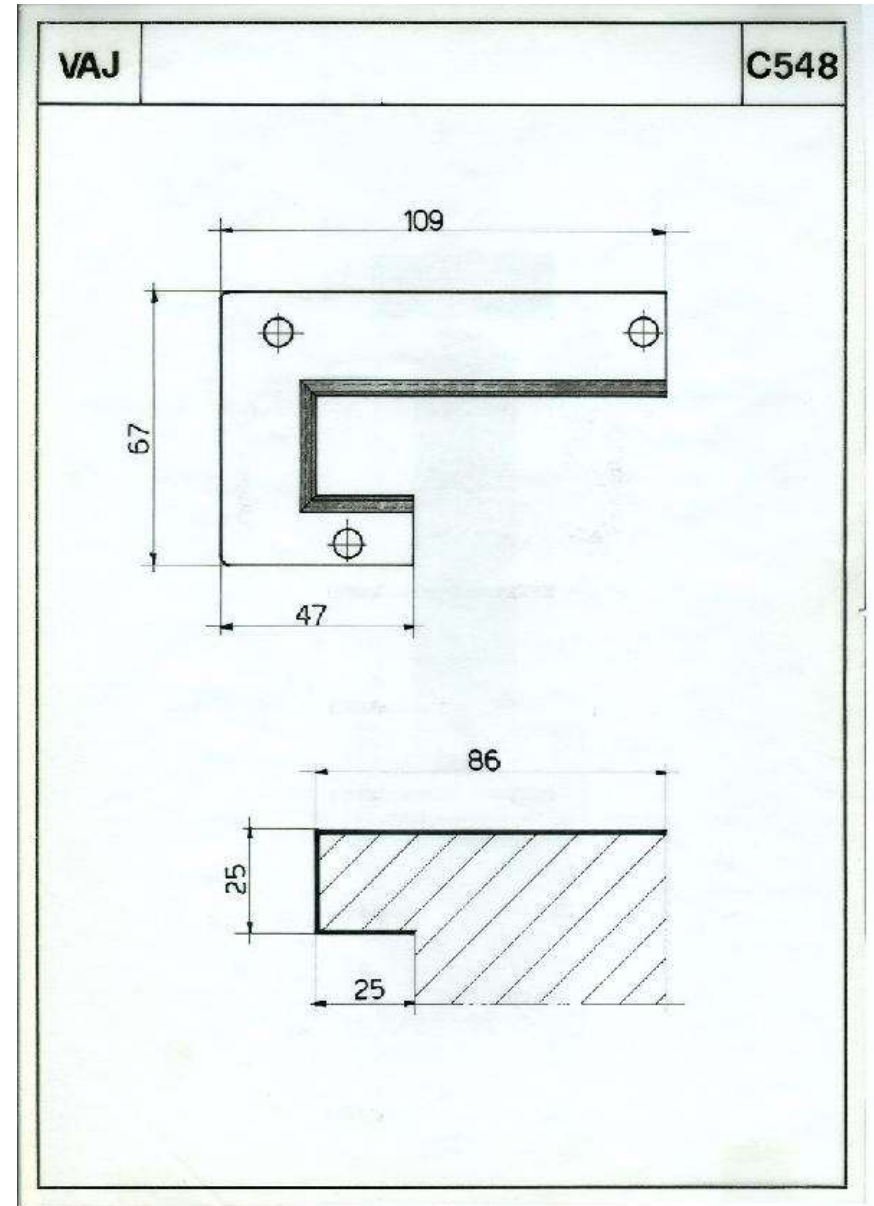
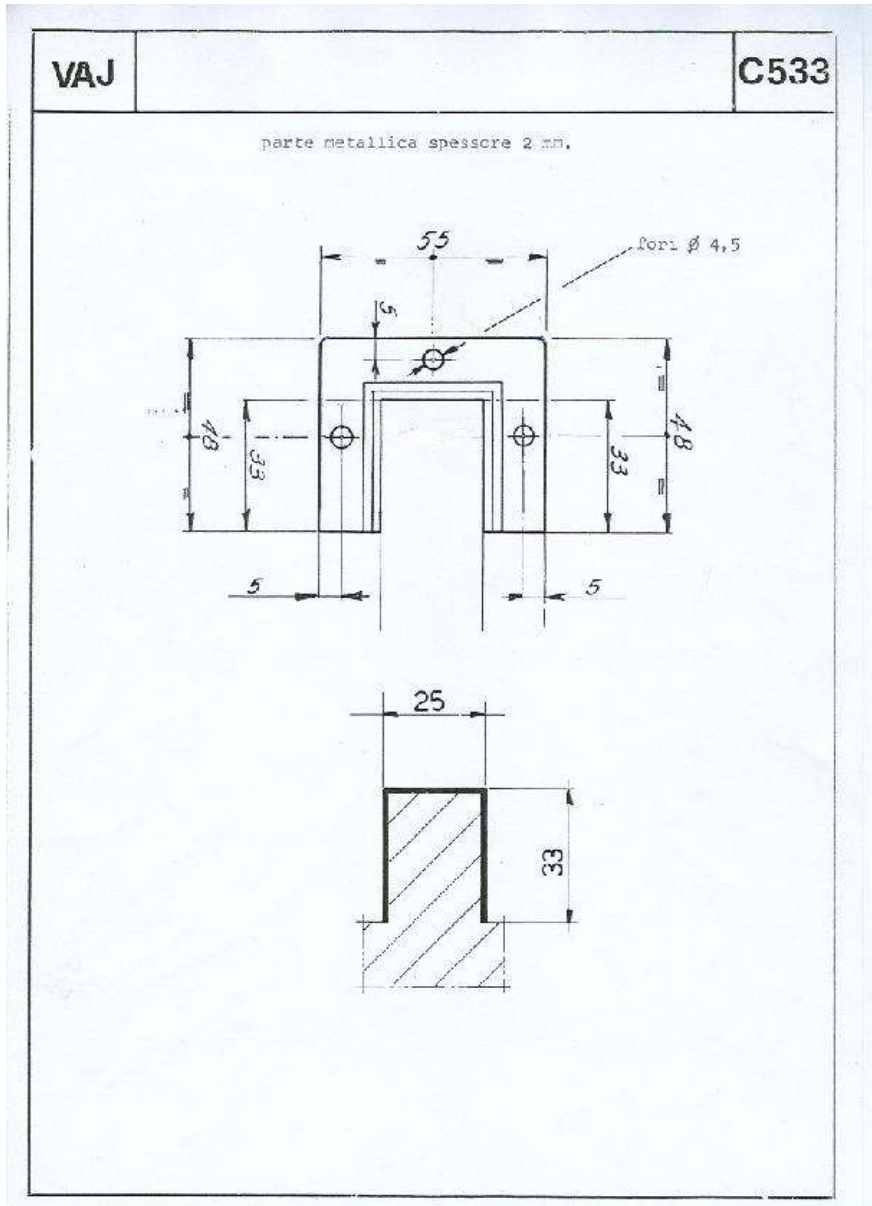

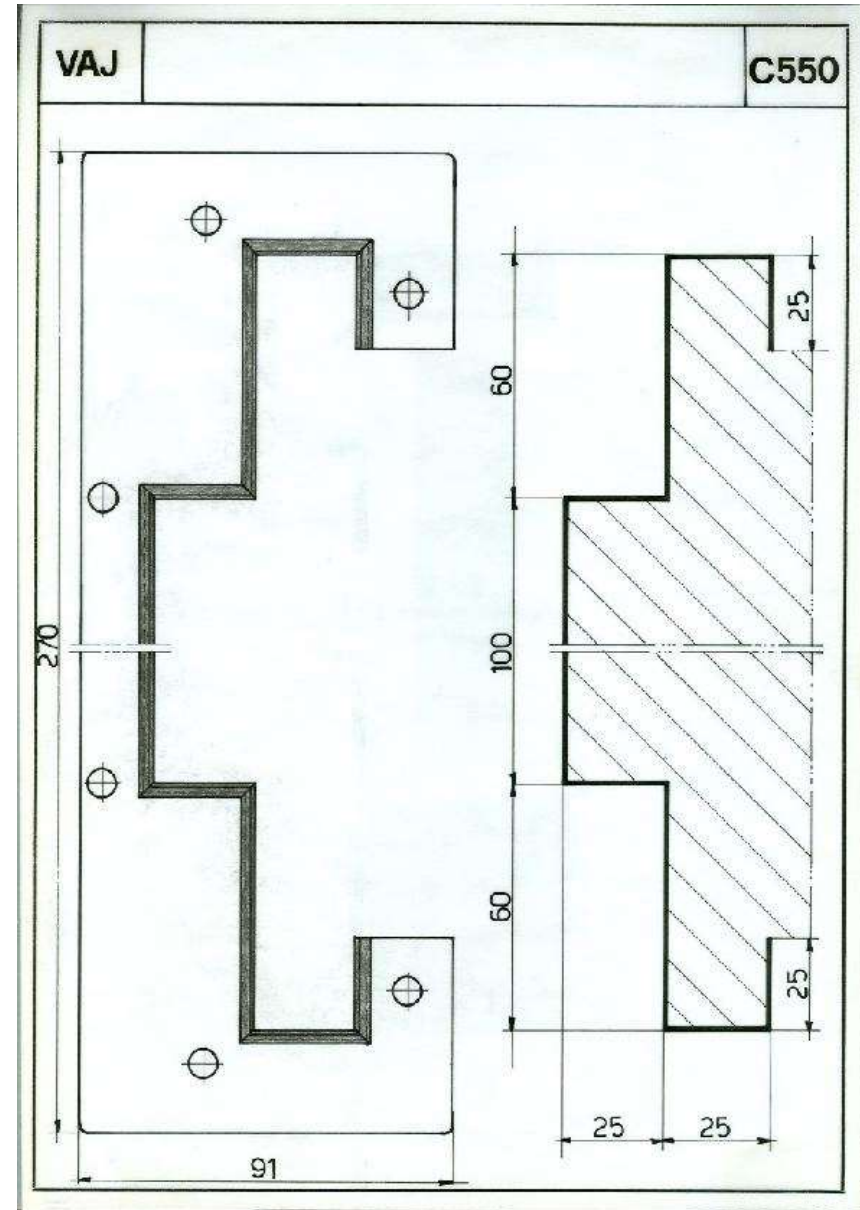
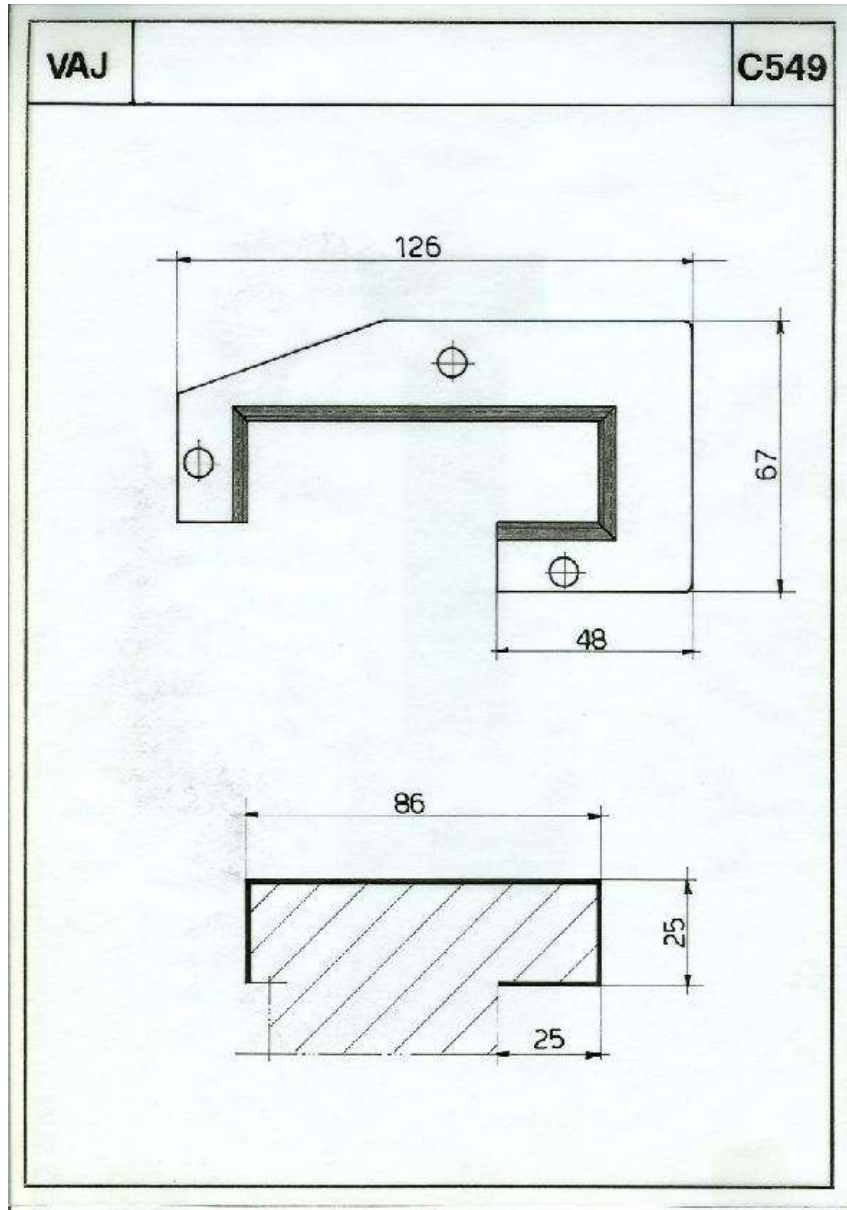

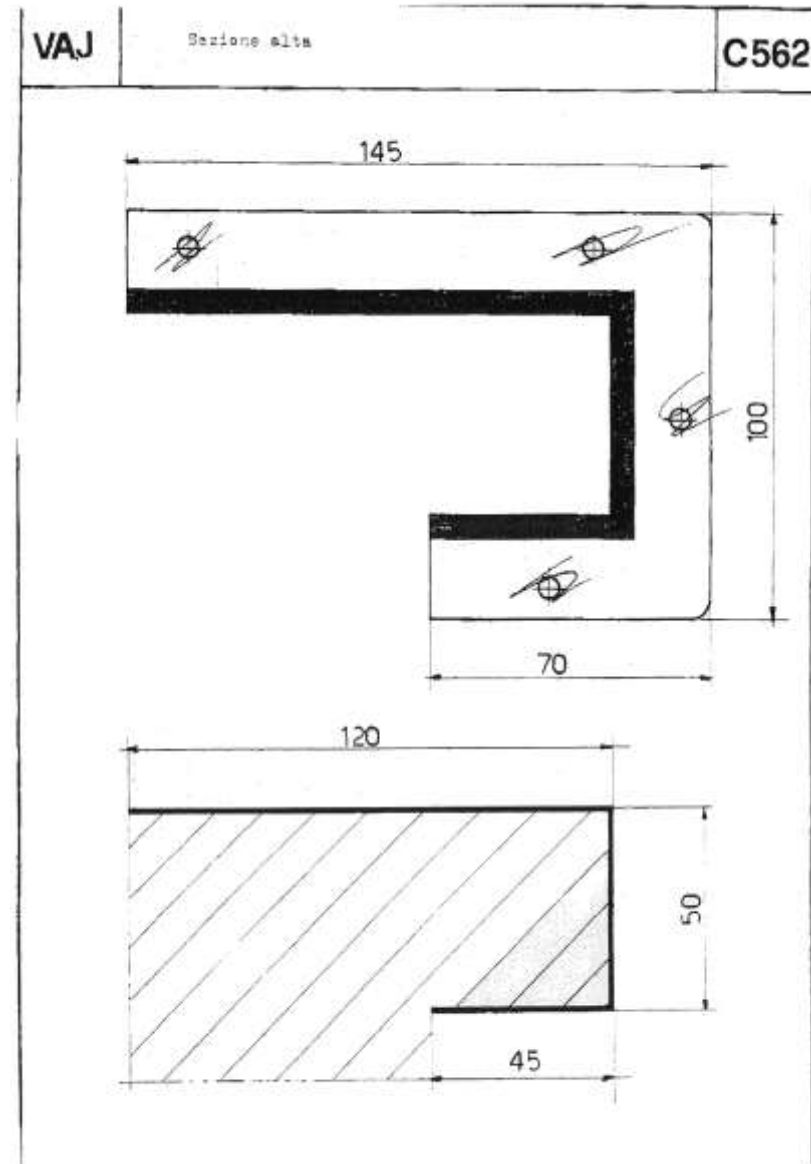
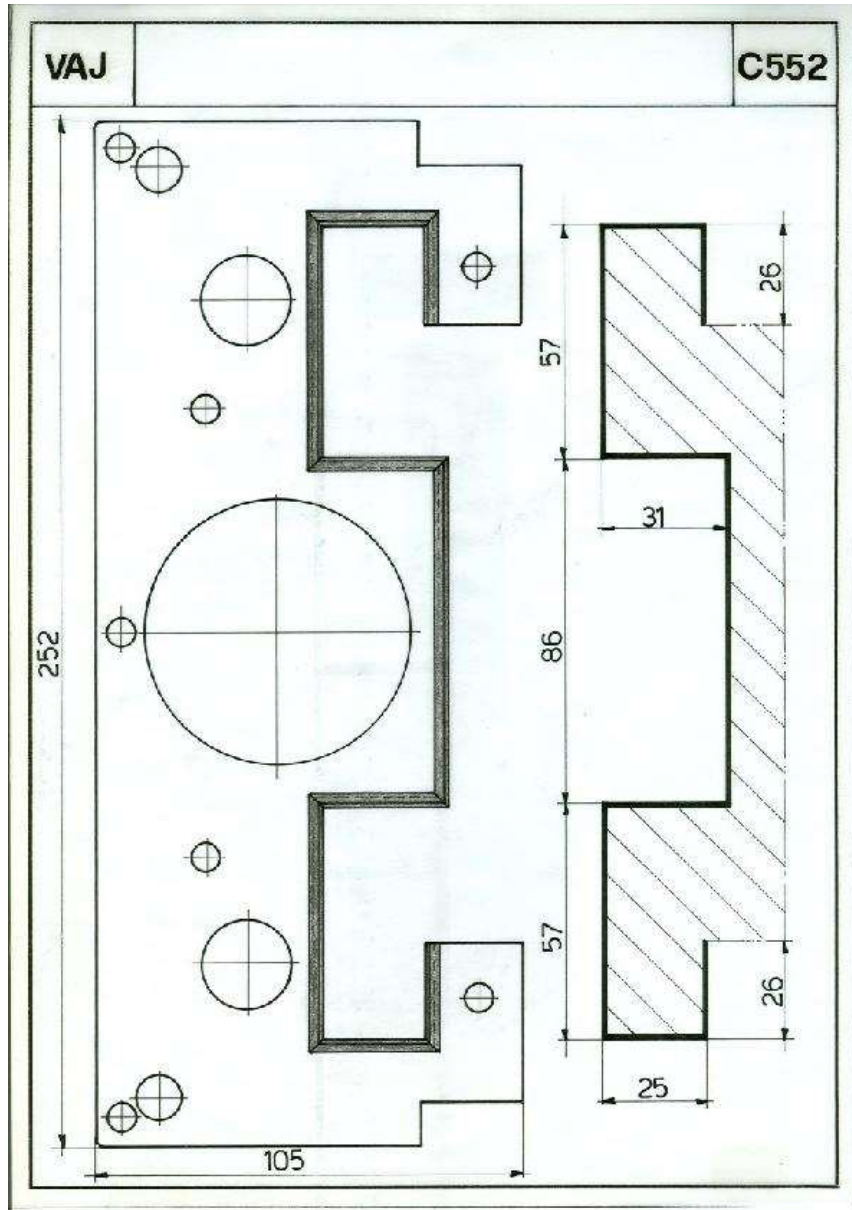

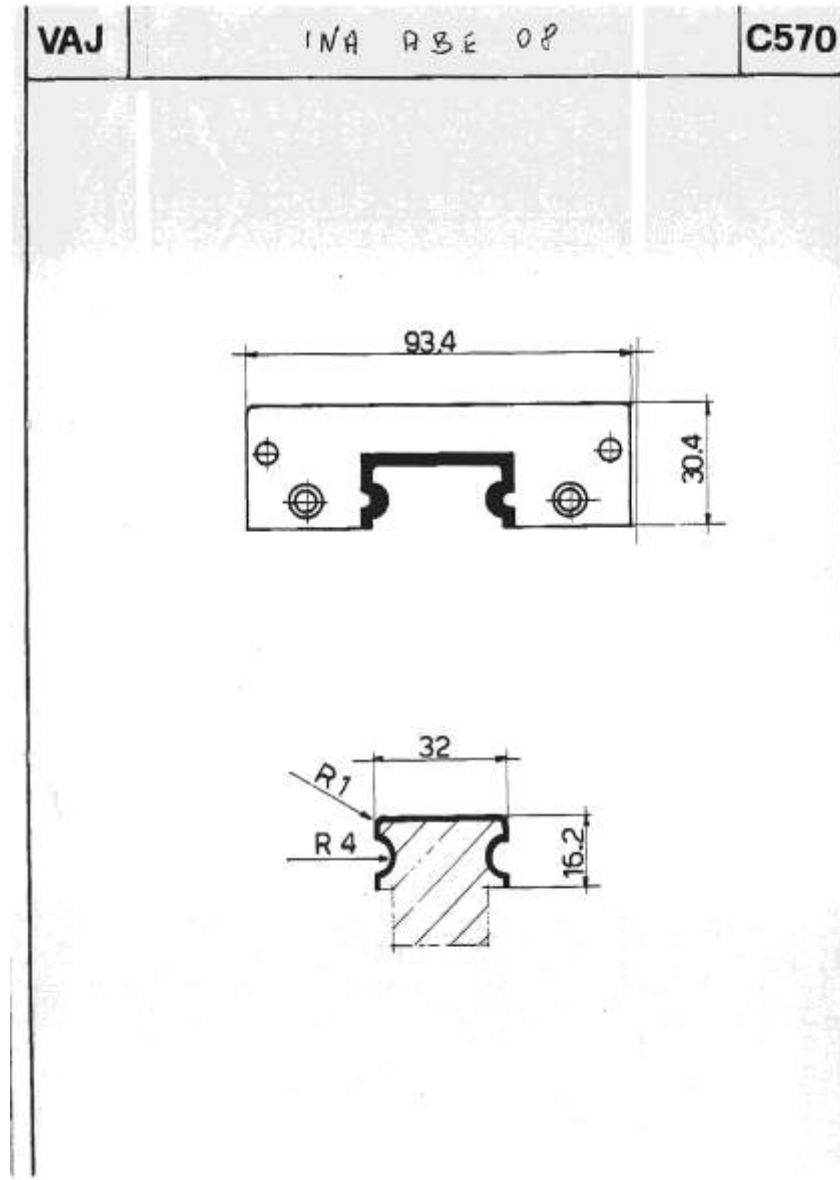
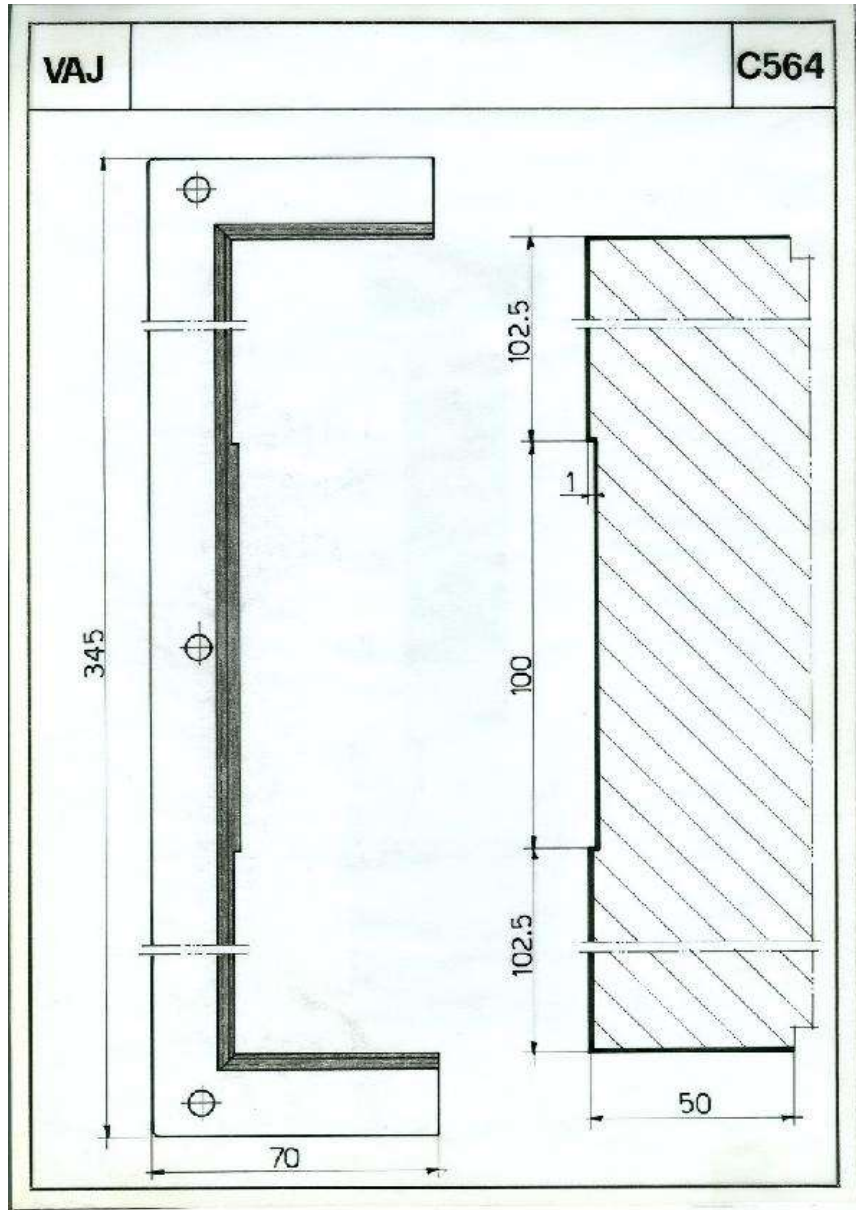

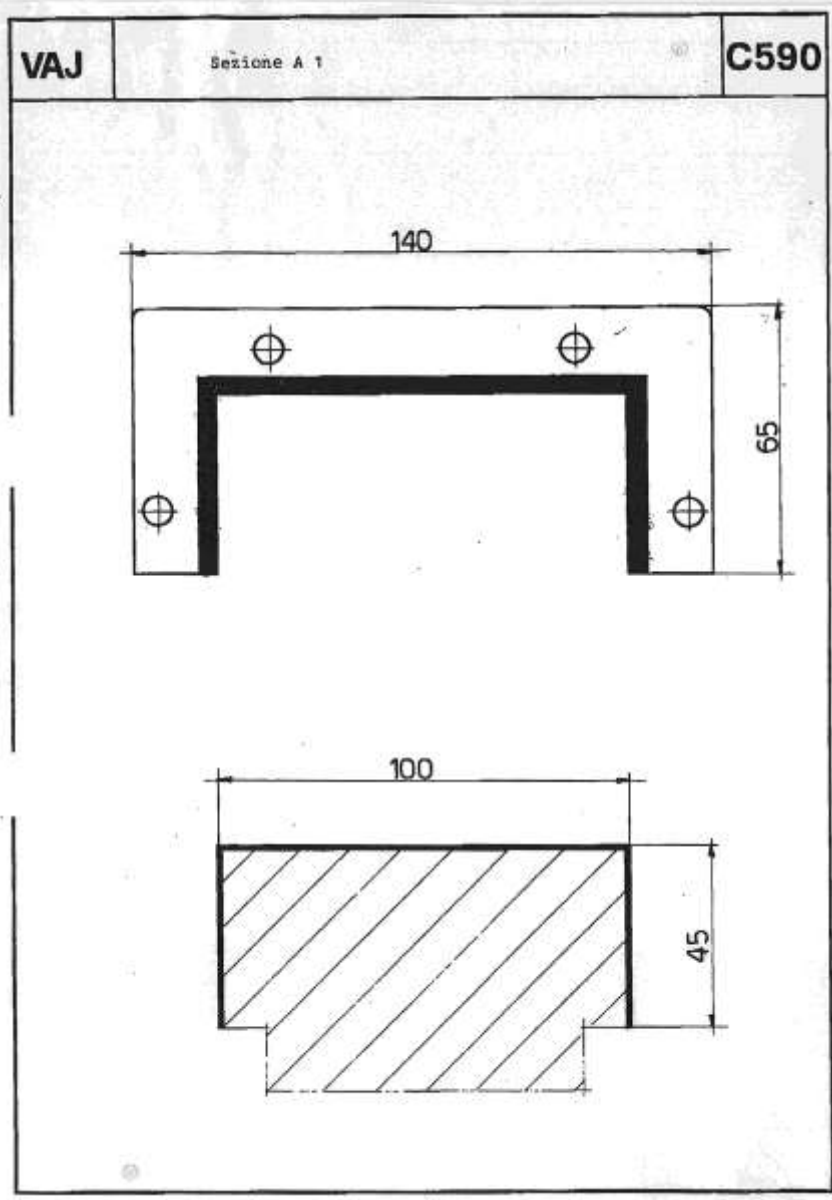
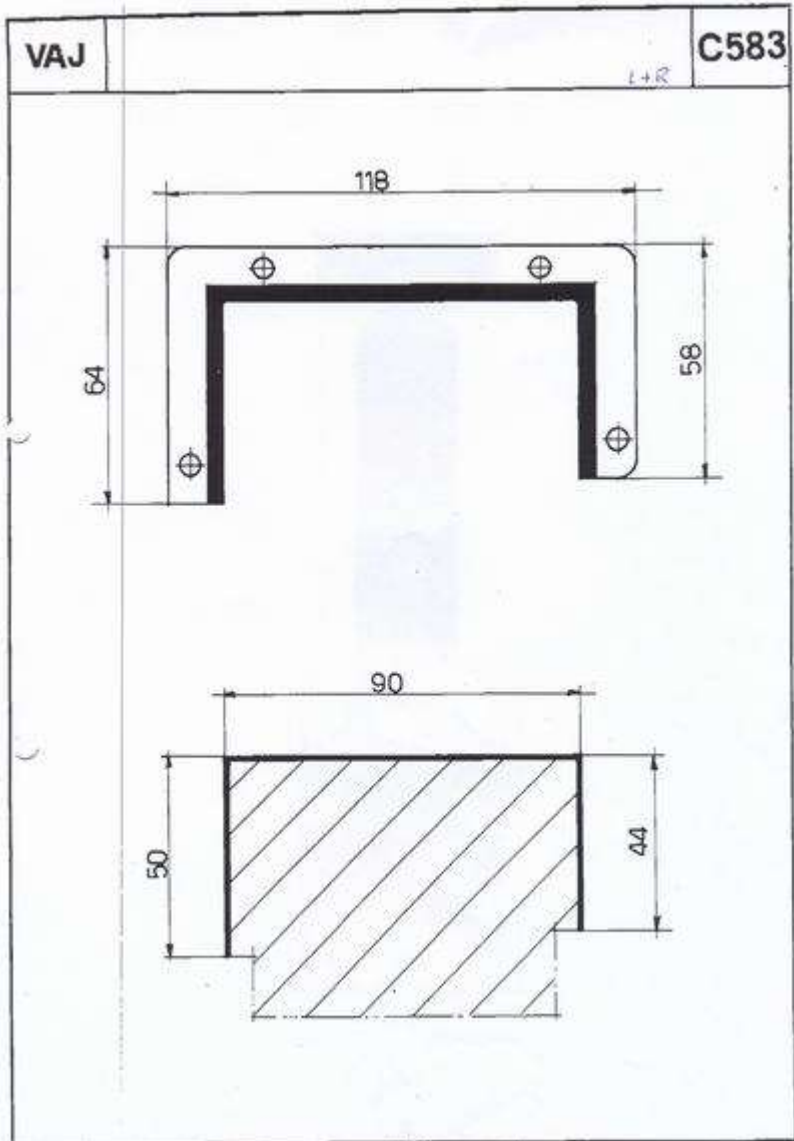

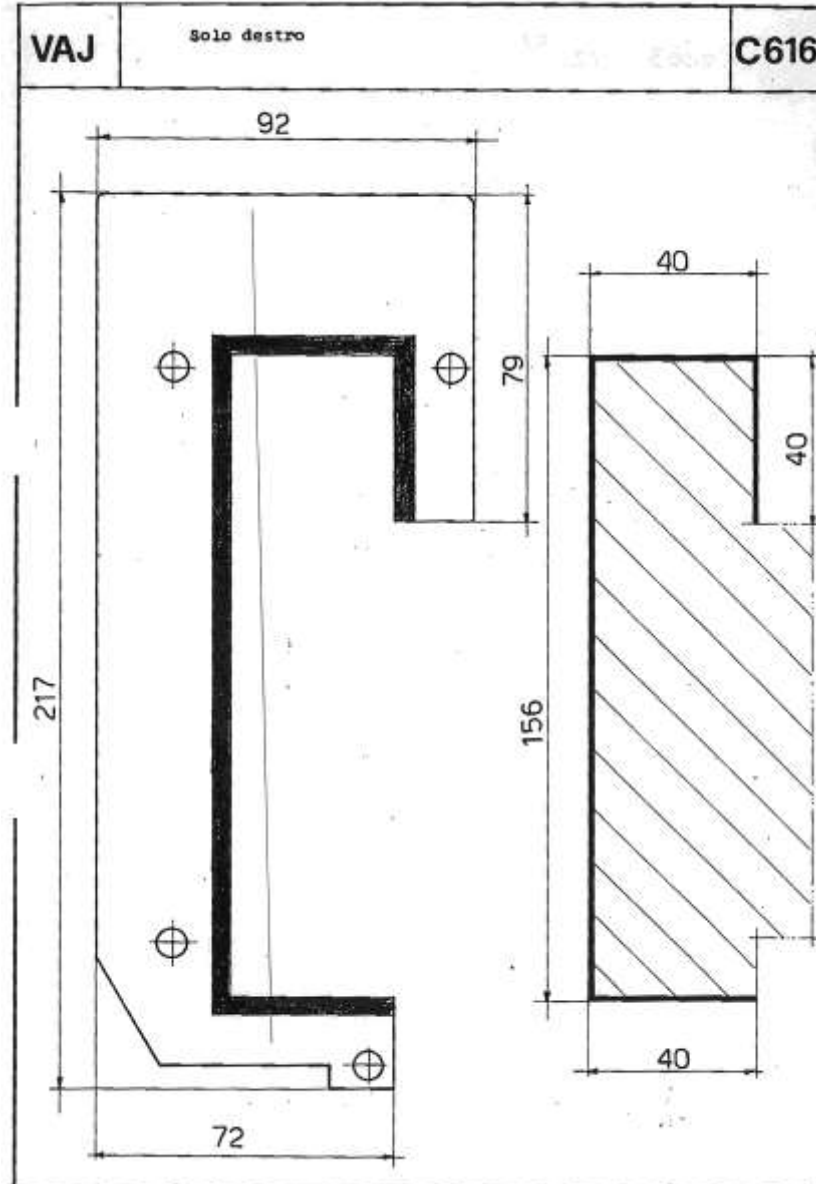
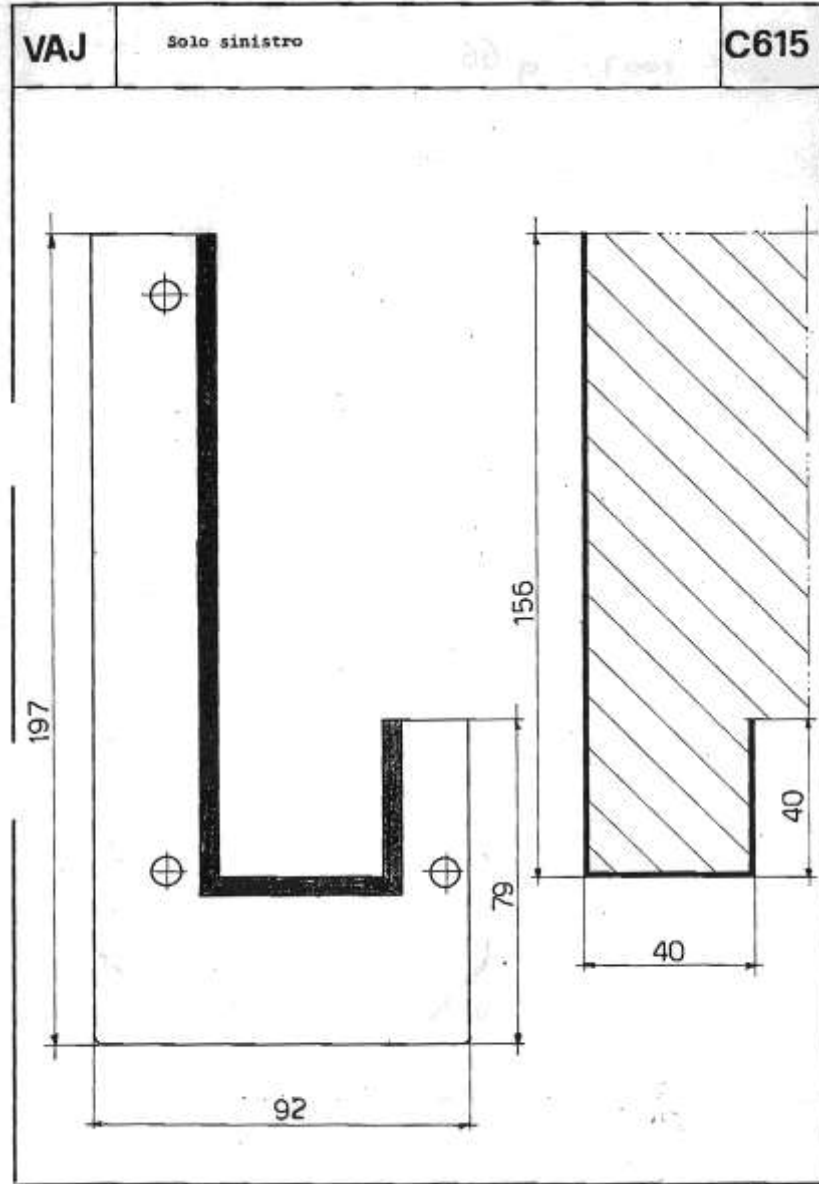

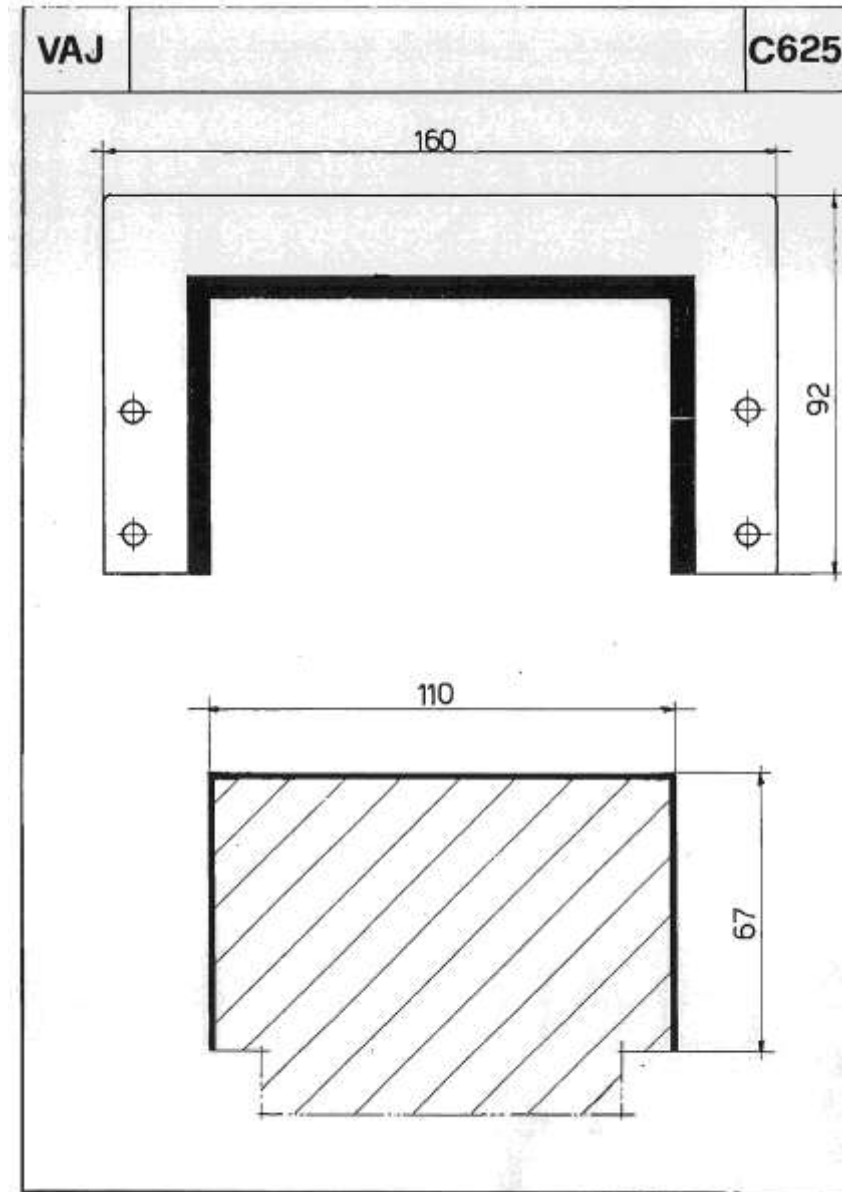
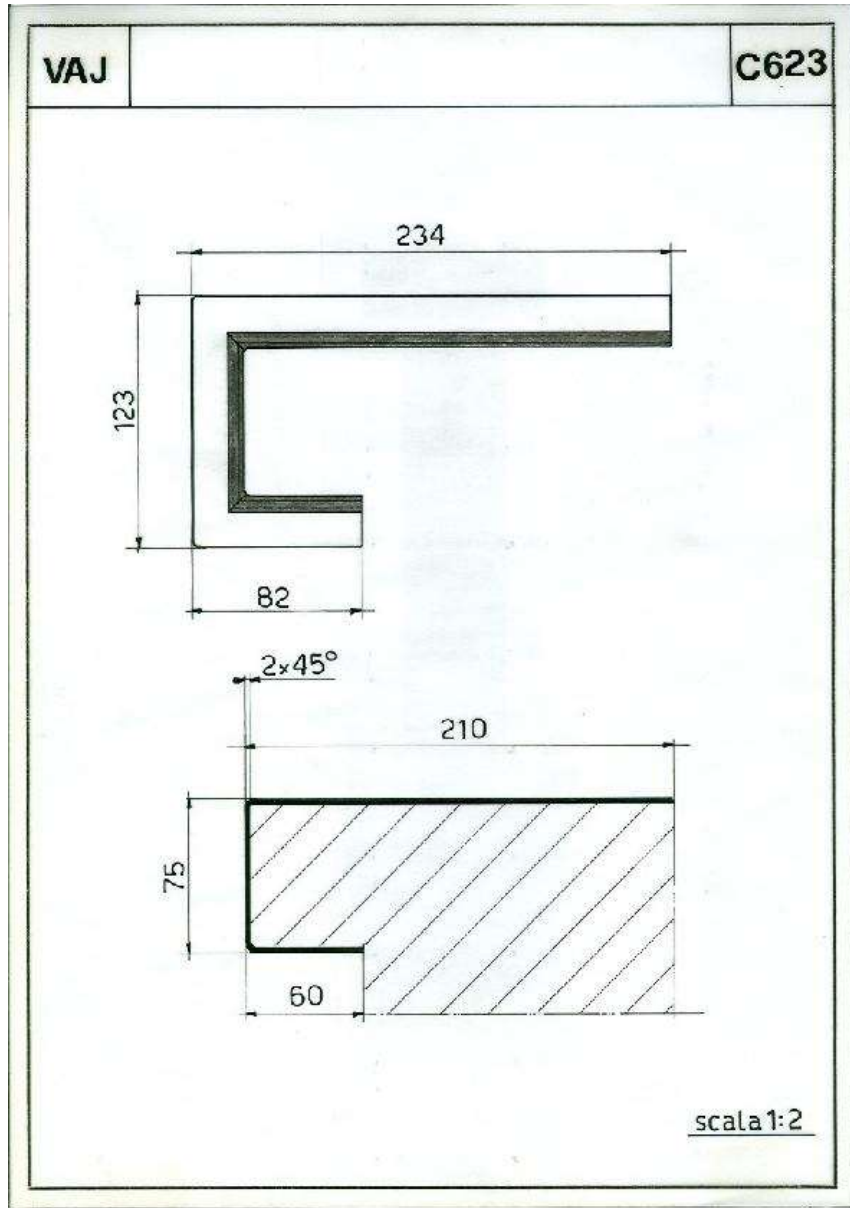

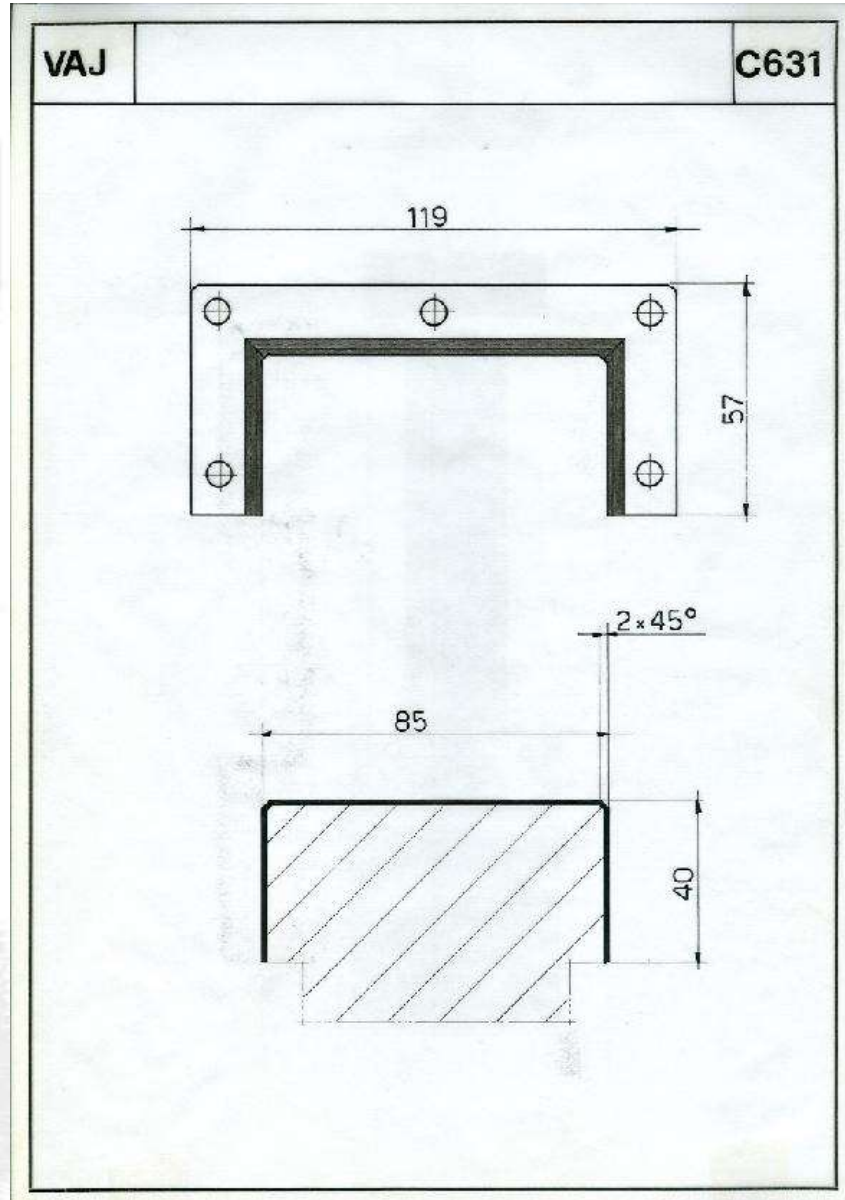
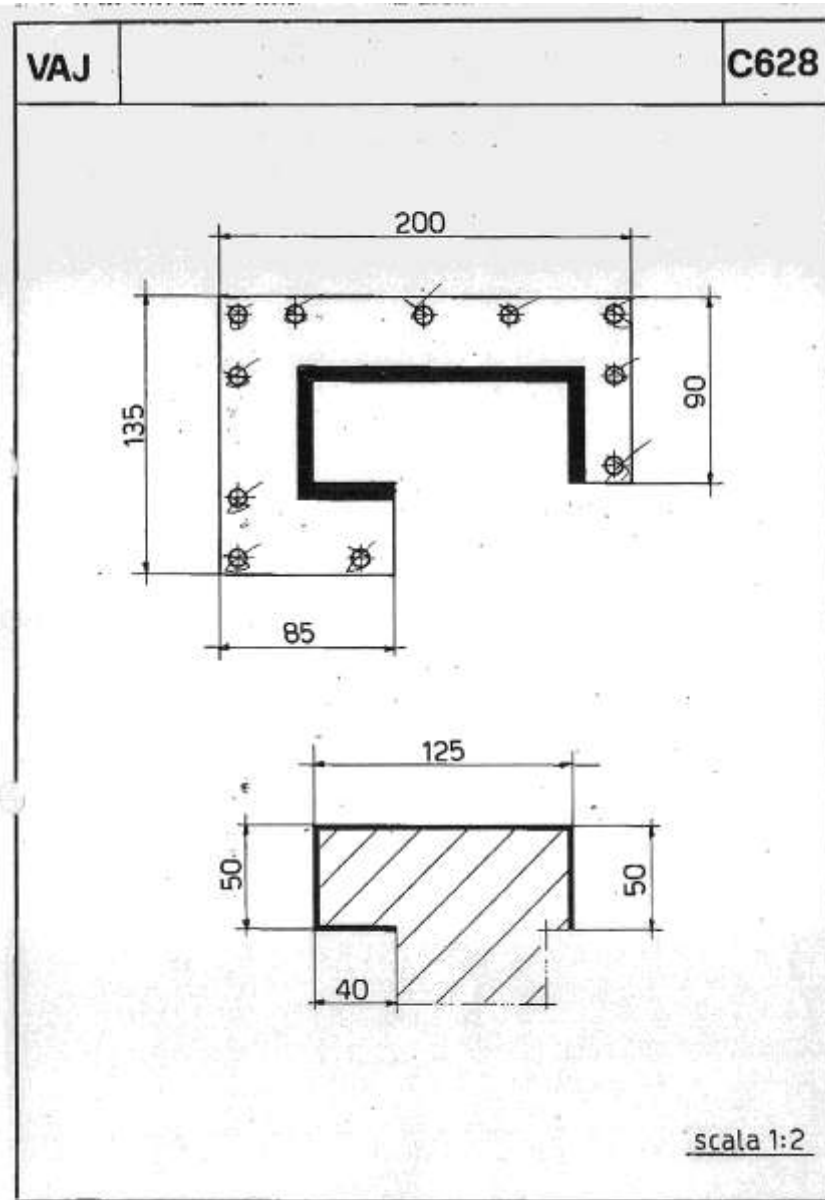

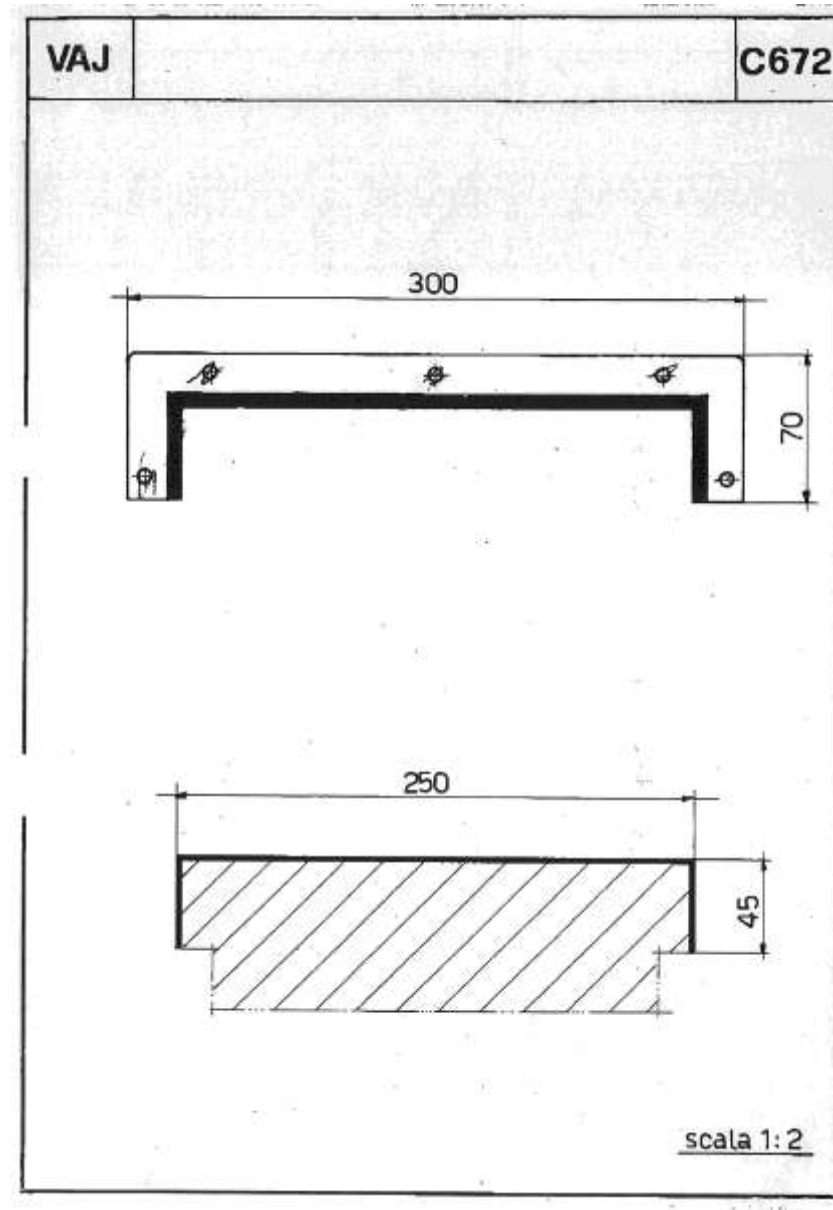
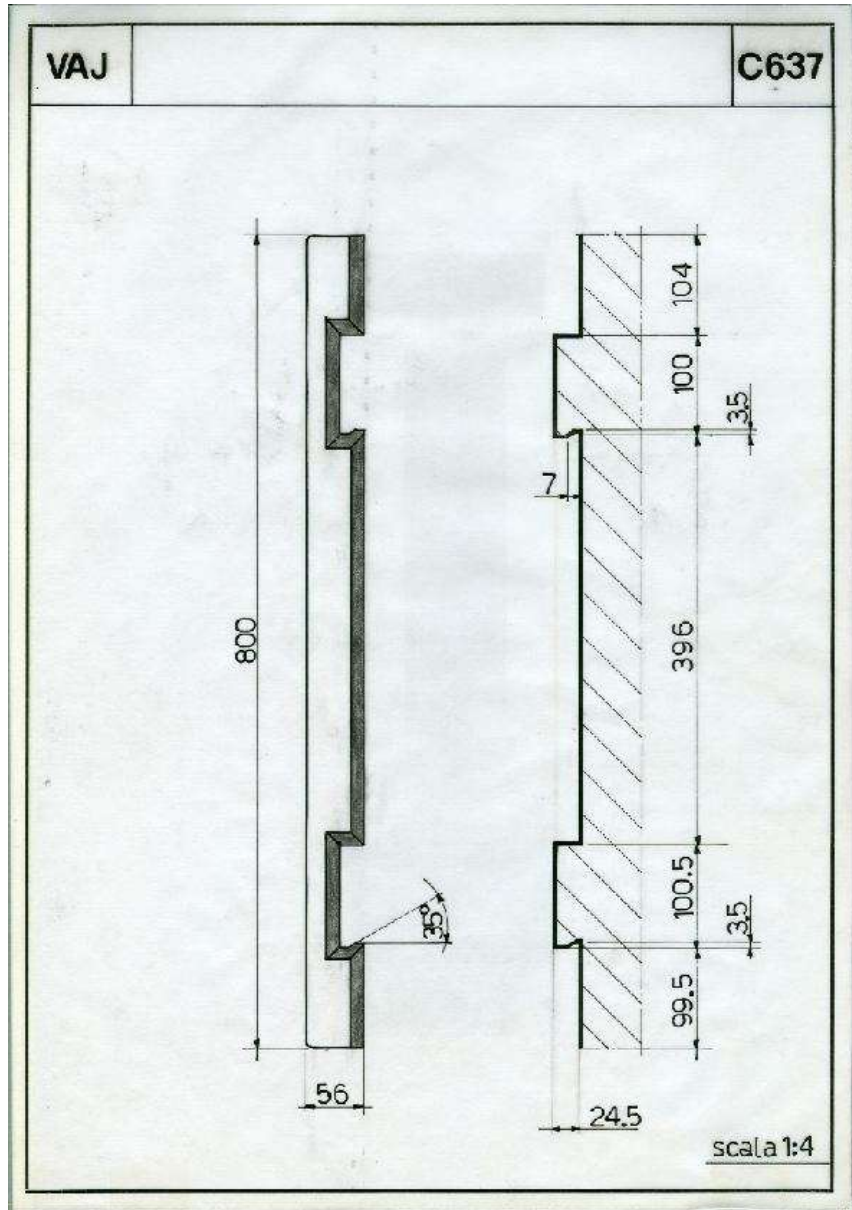

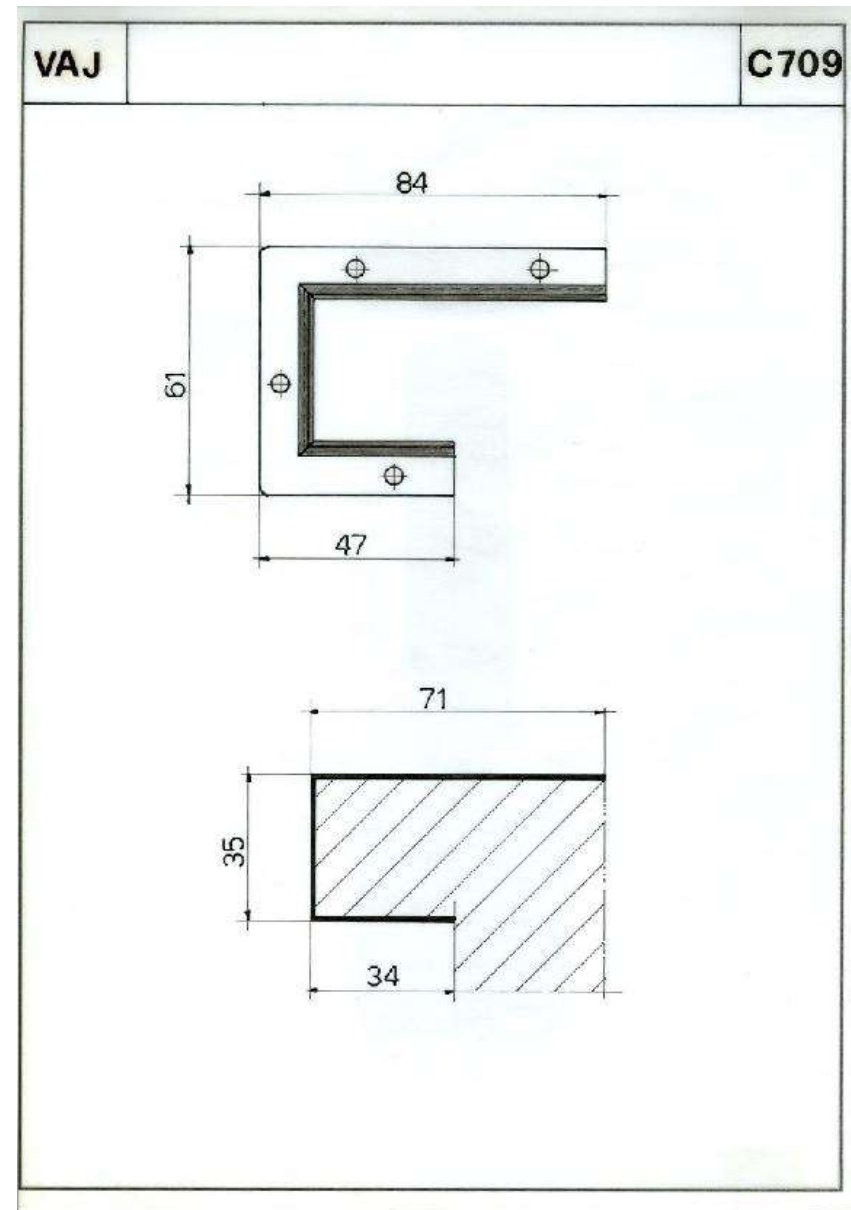
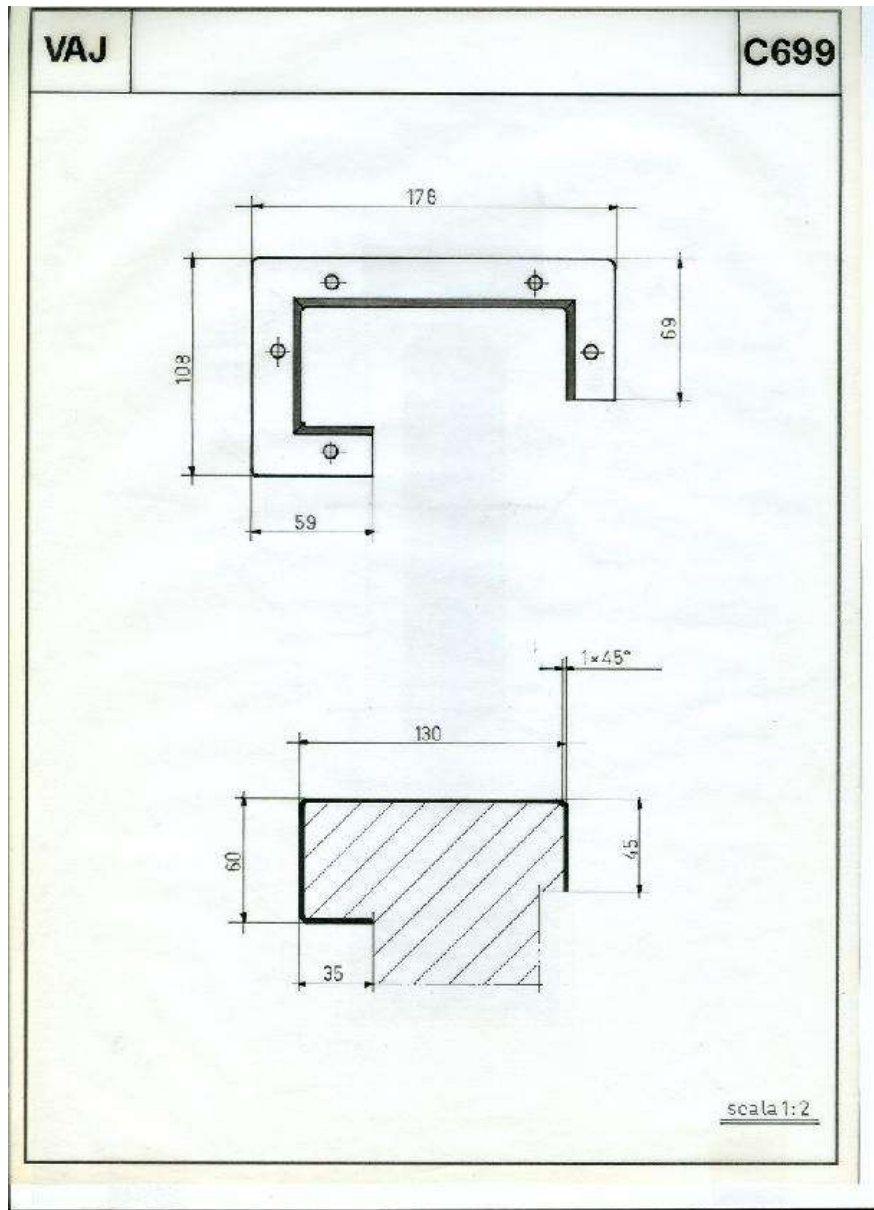

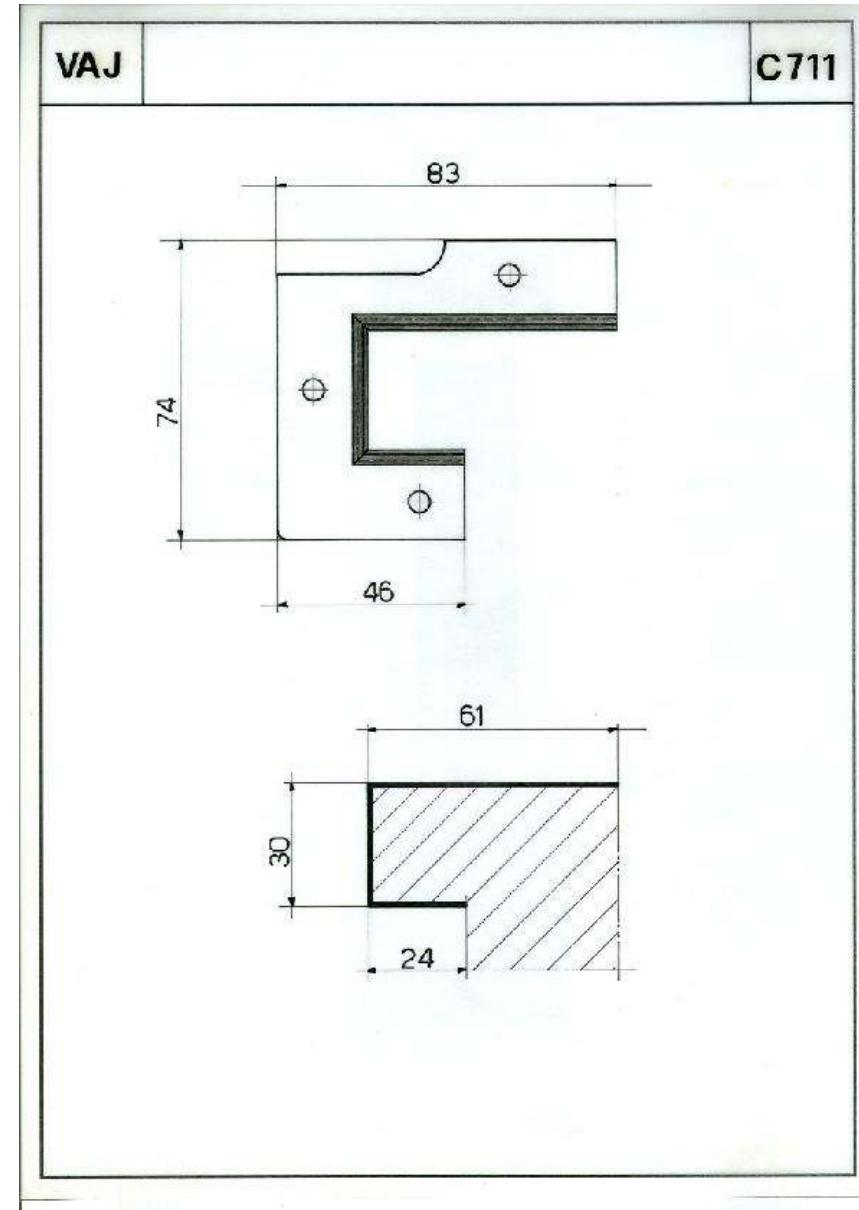
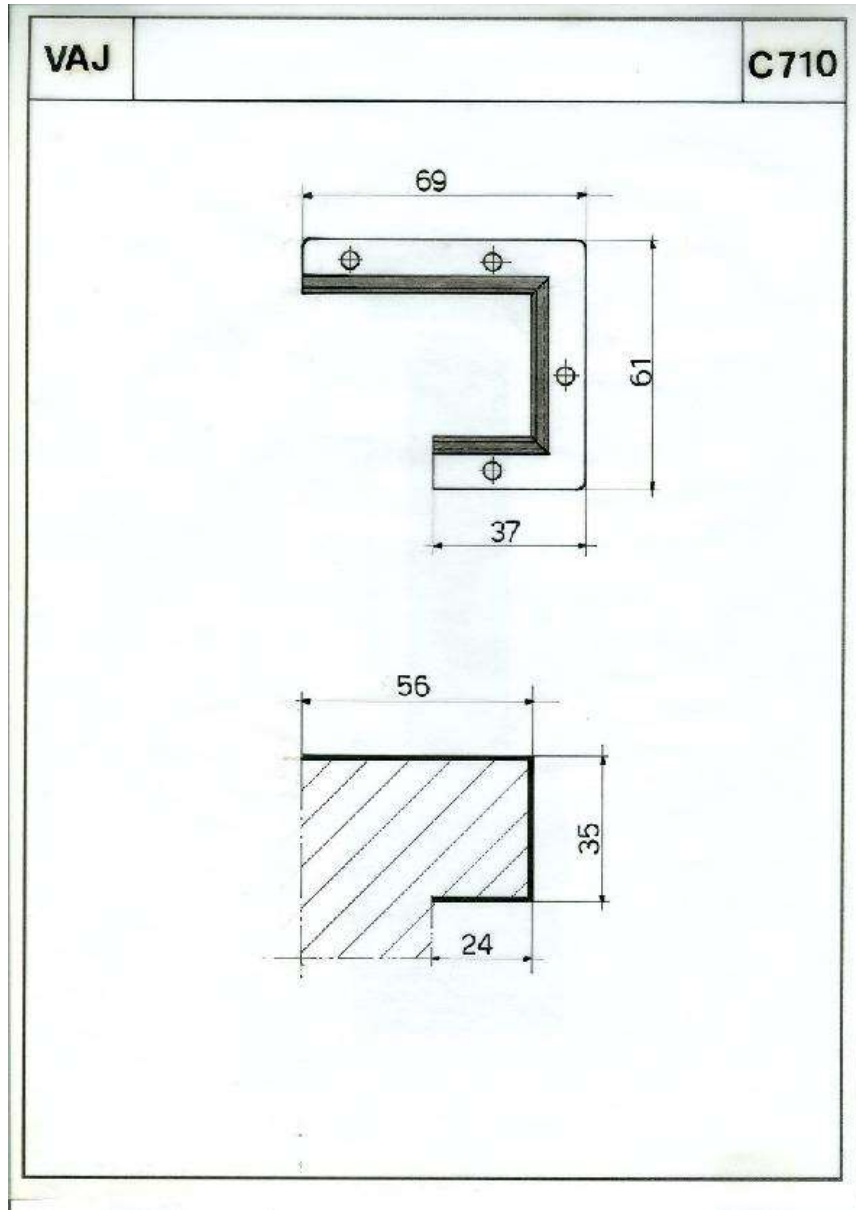

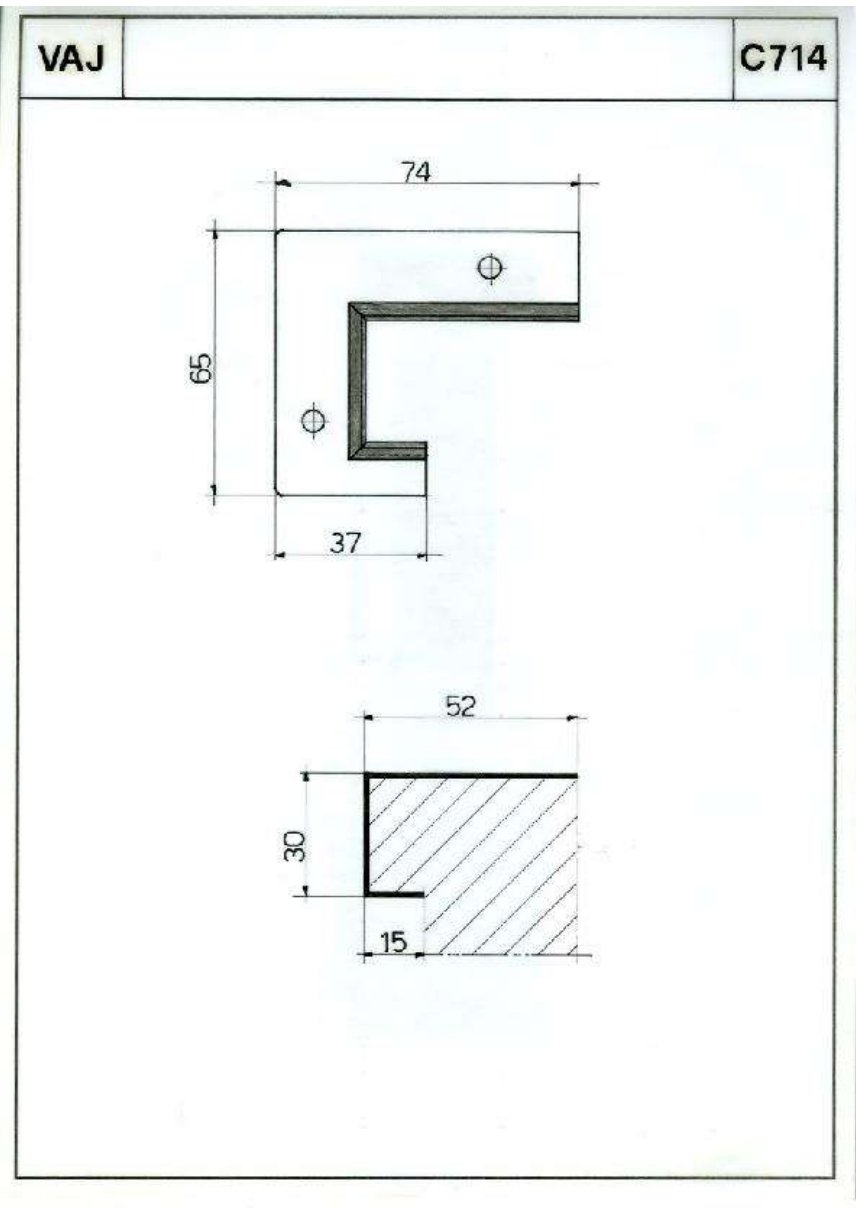
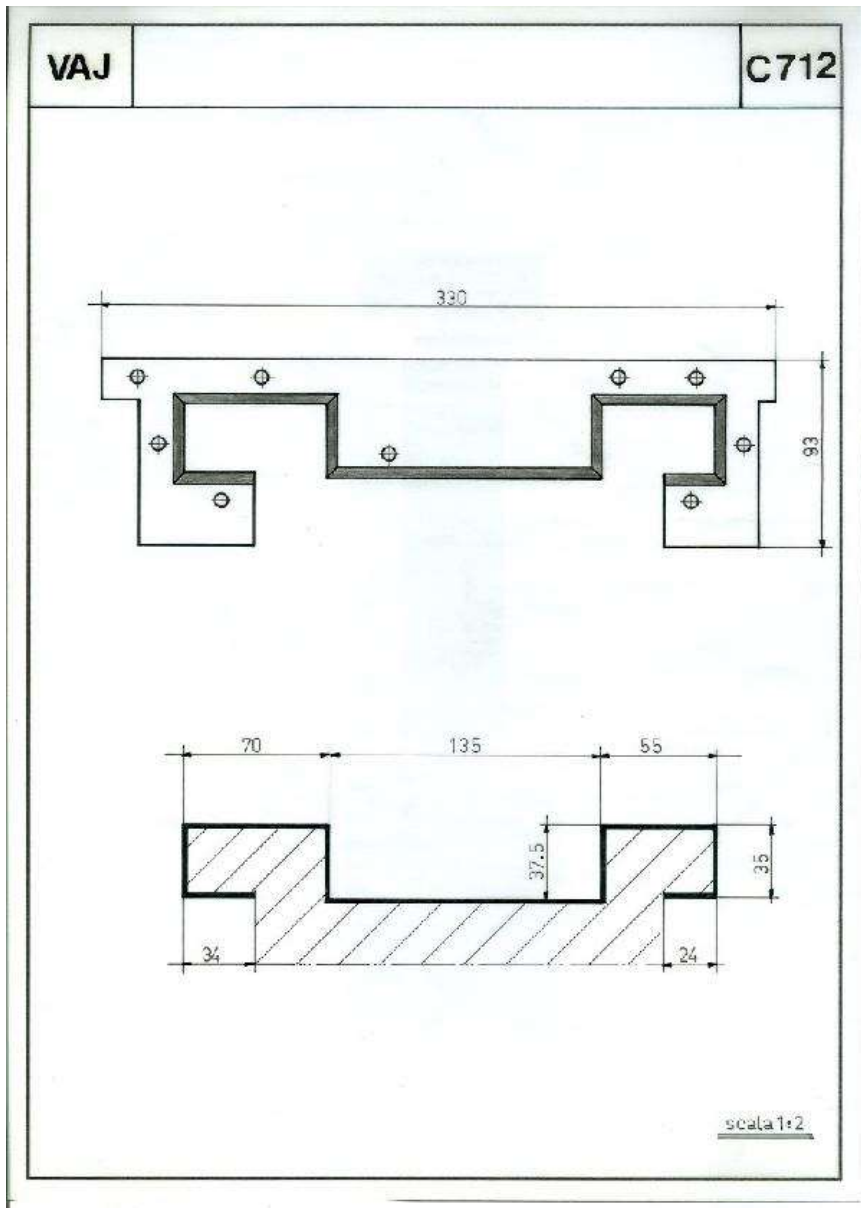

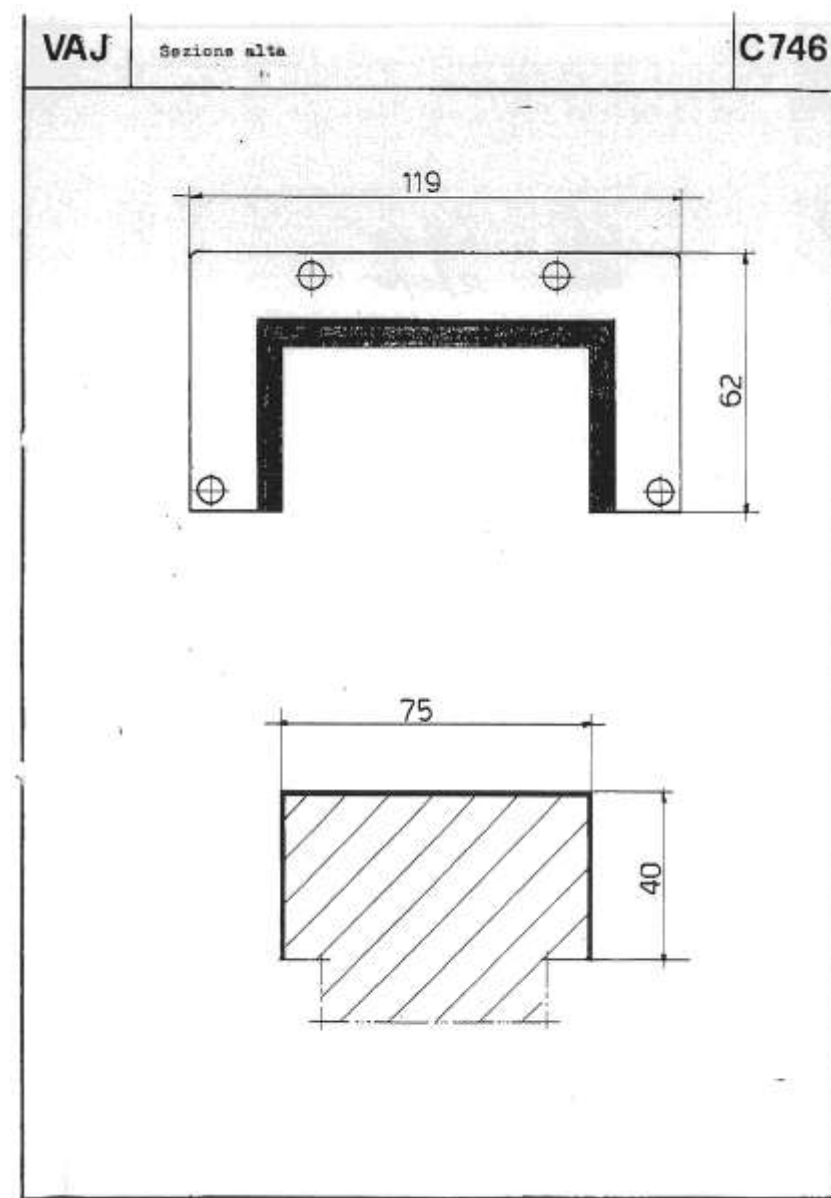
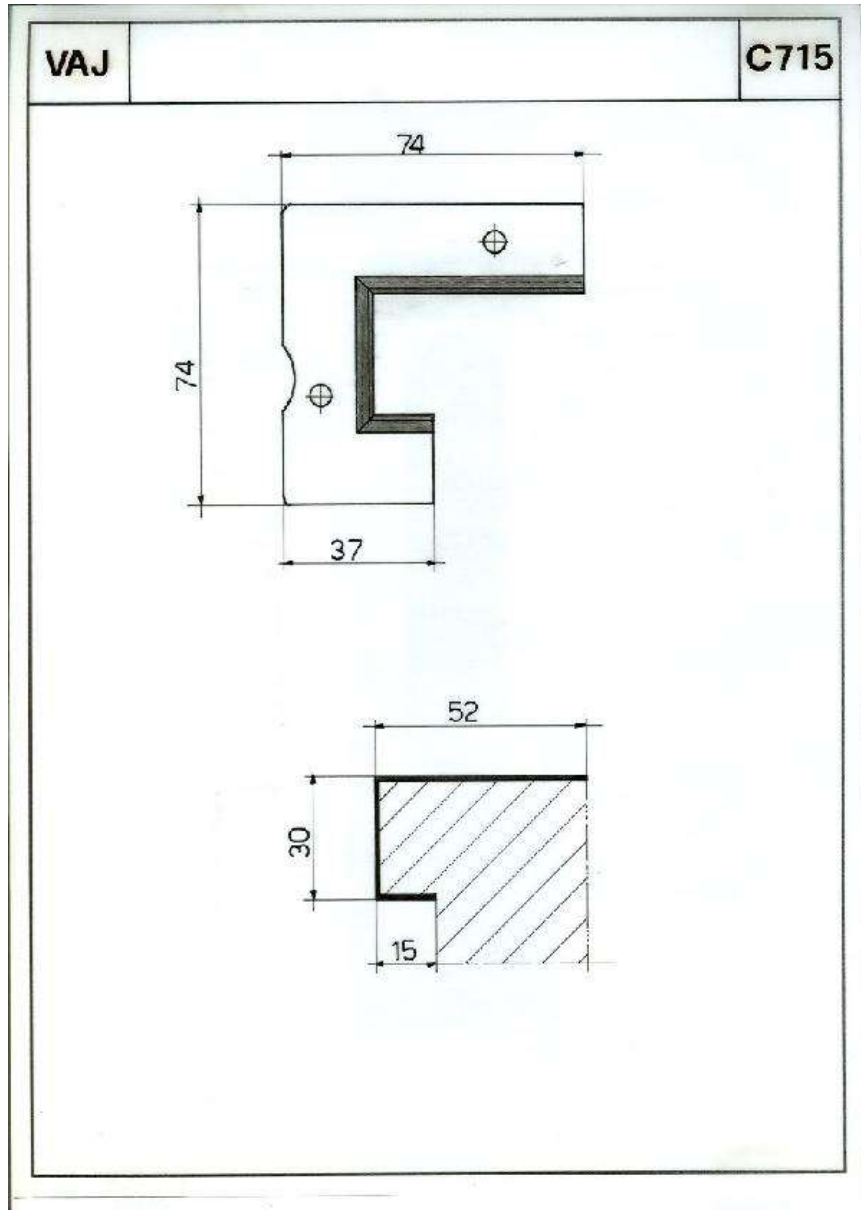

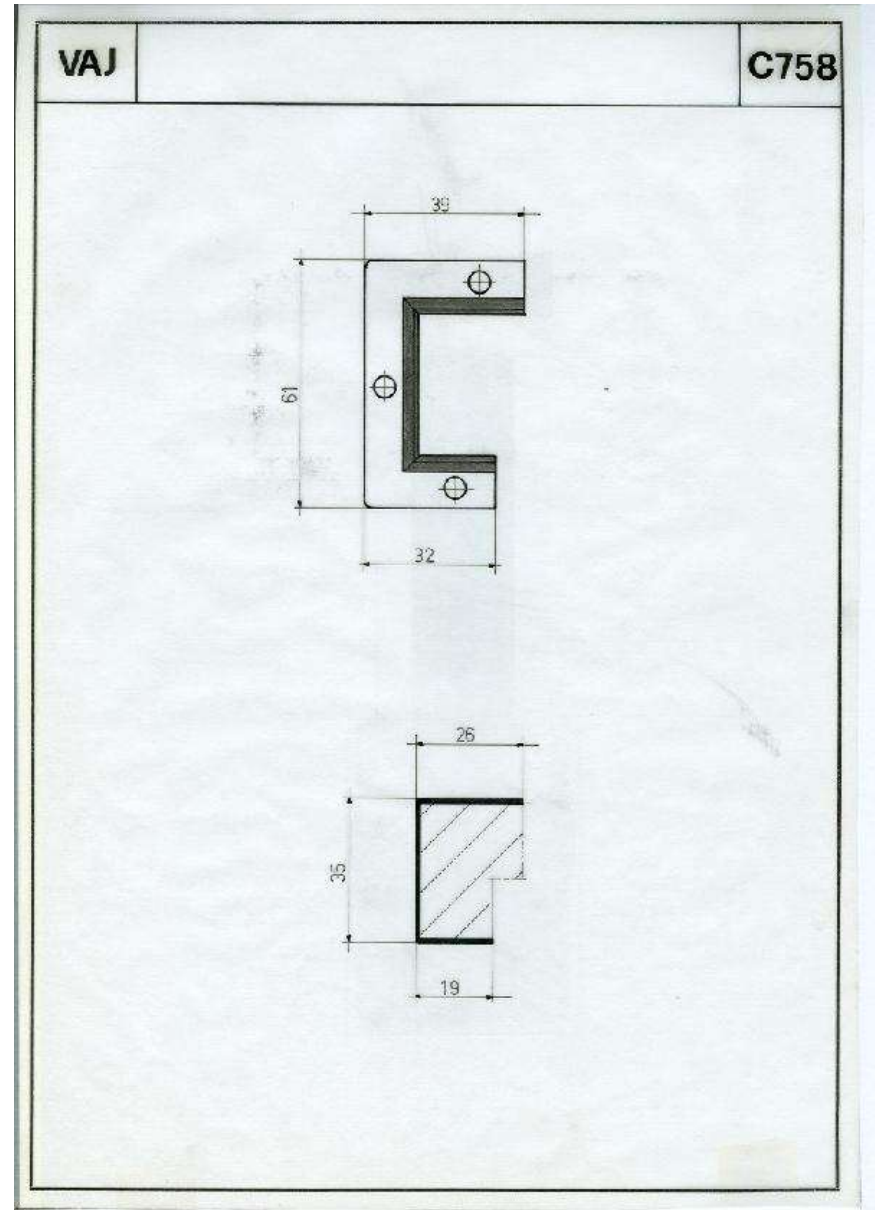
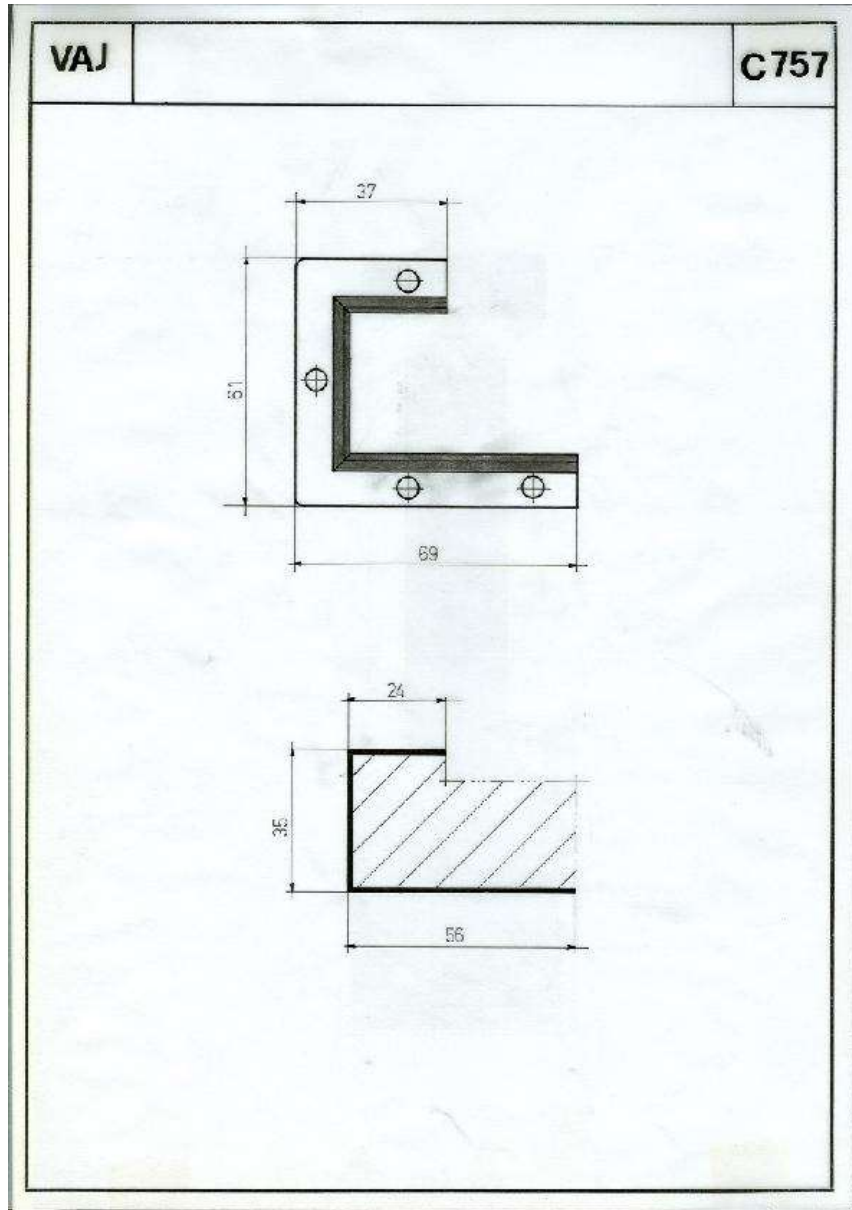

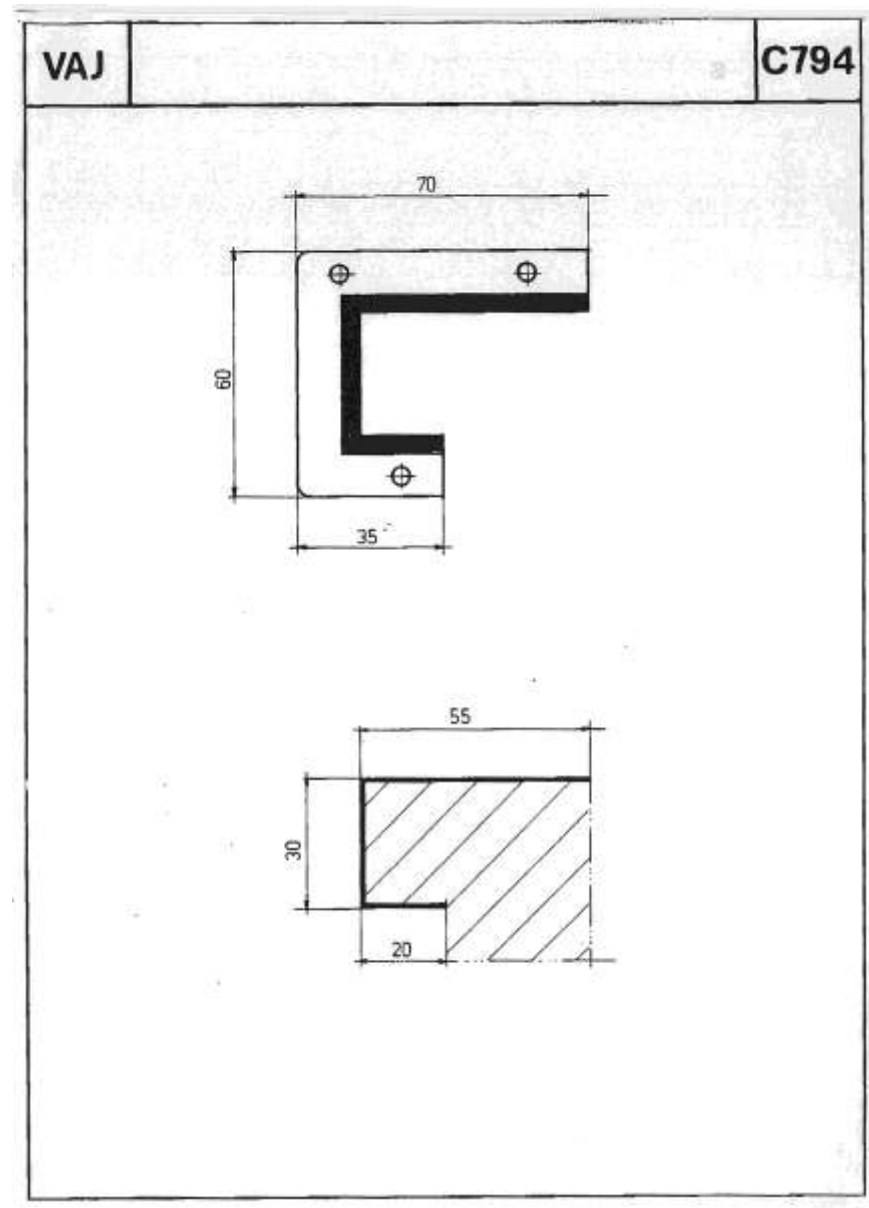
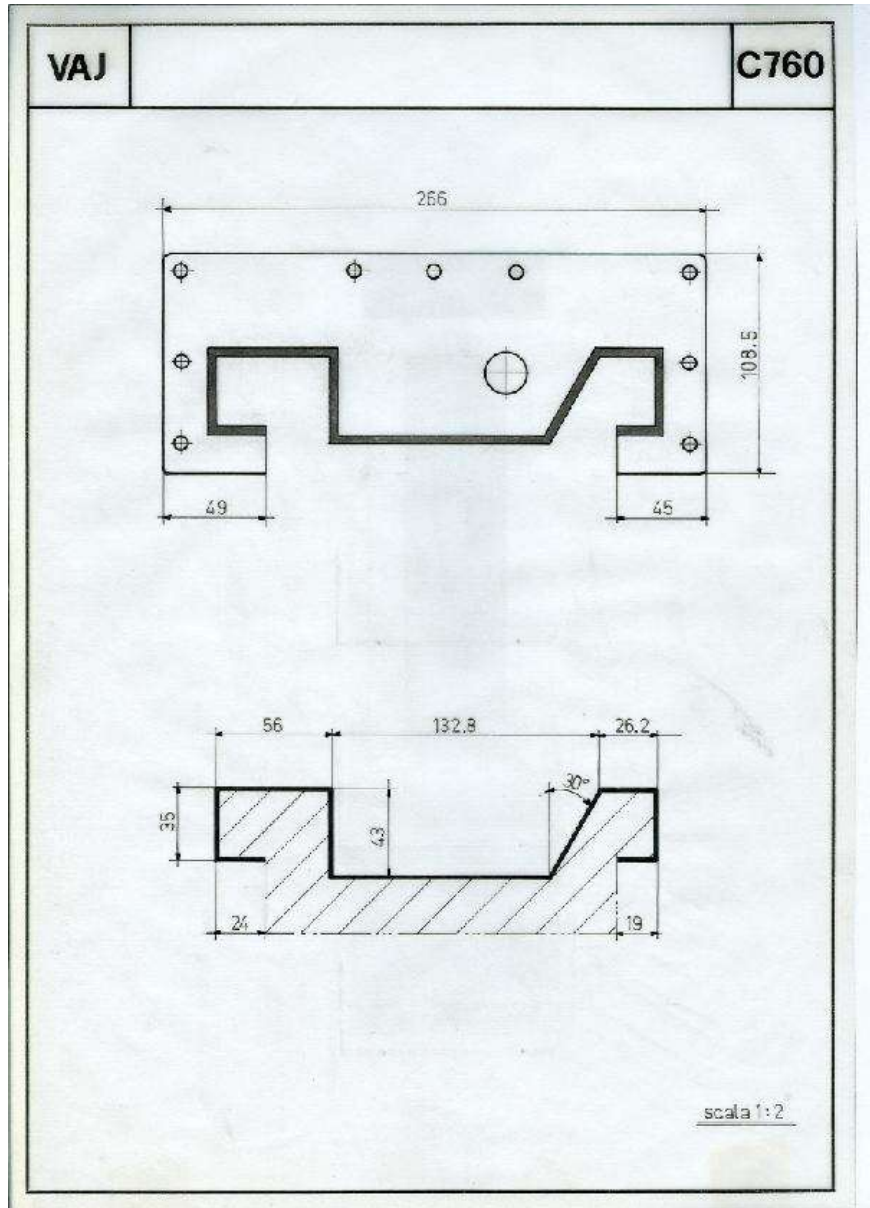

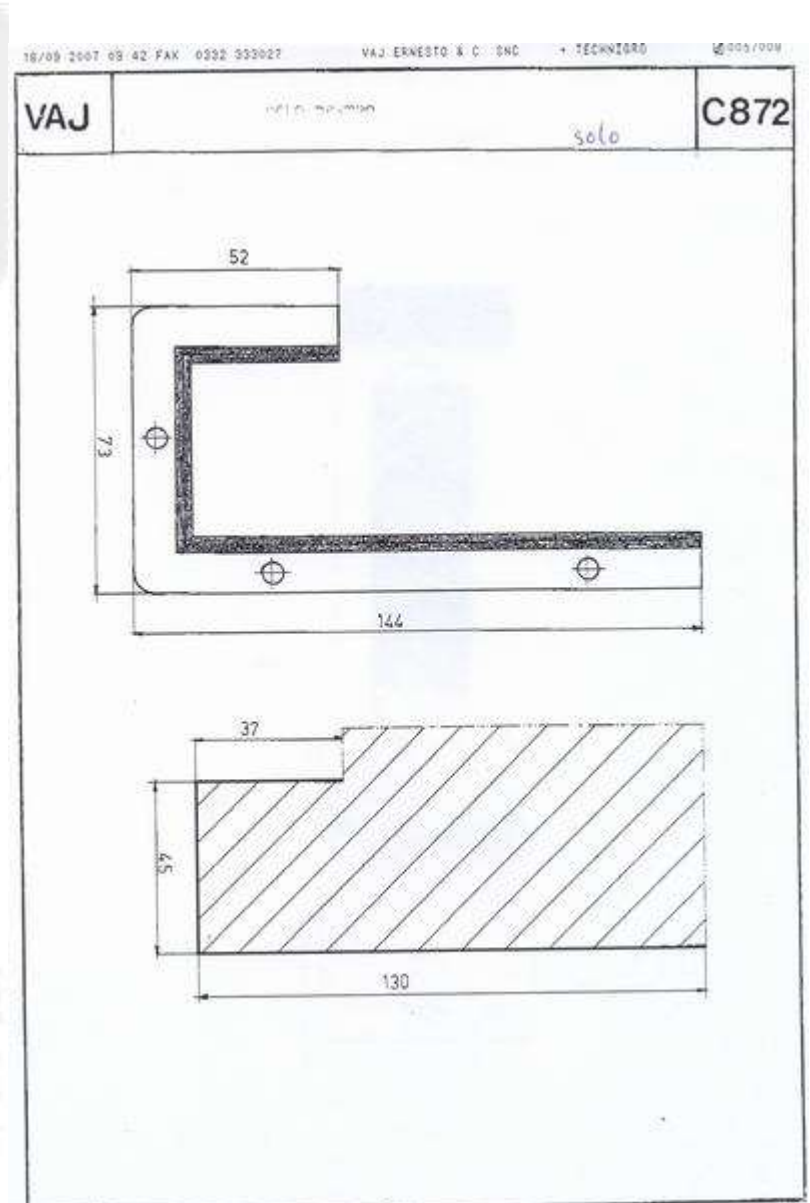
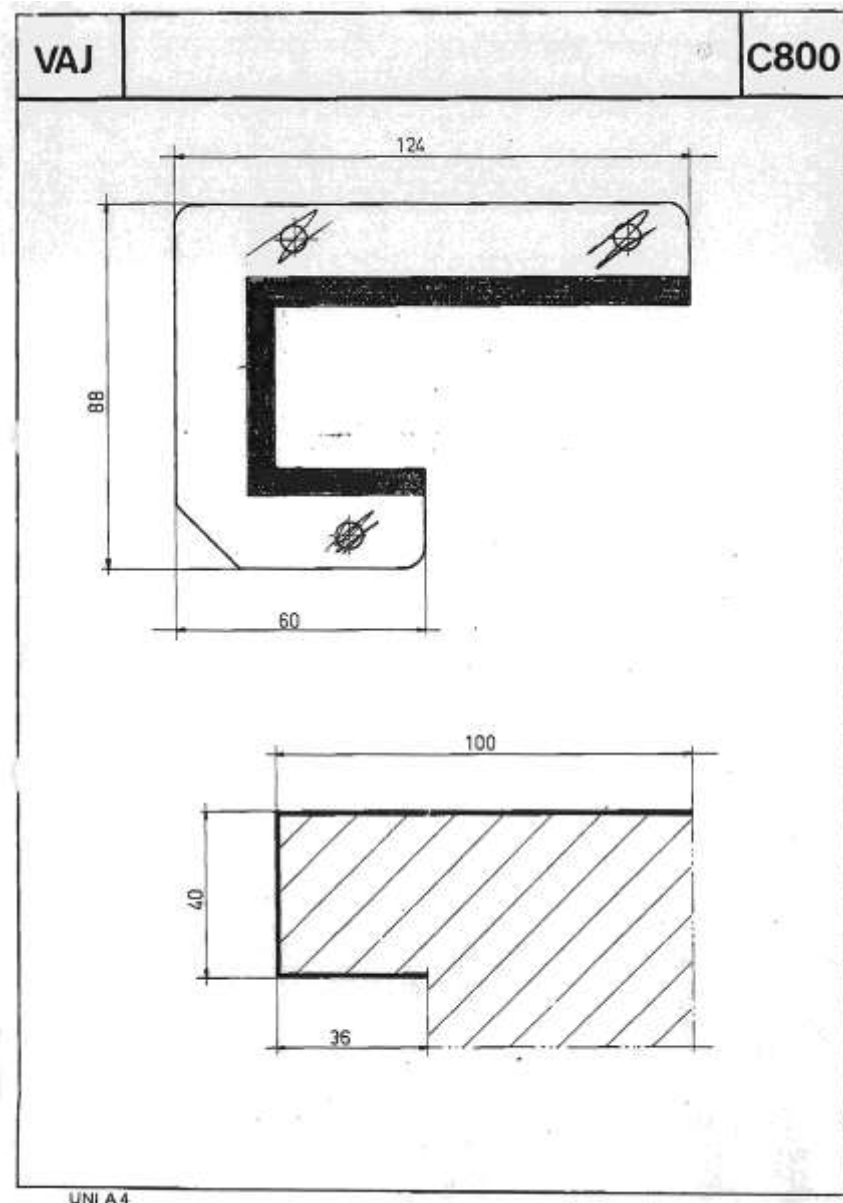

18/08 2007 08:42 FAX 0332 333027 VAJ ERNESTO & C. SNC * TECHNIGRO 000/000

VAJ Solo destro C873

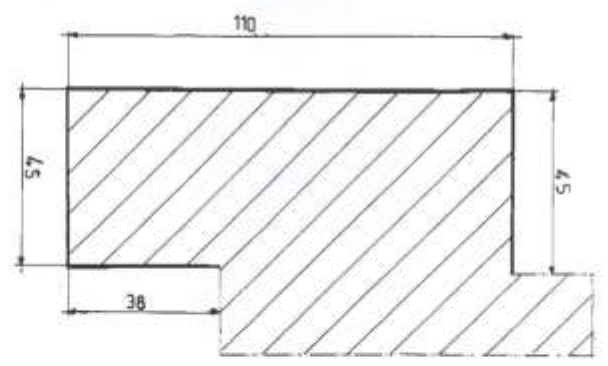
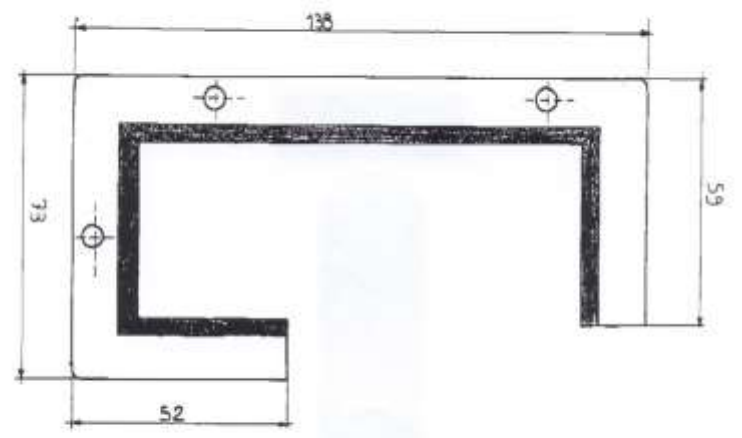

18/08 2007 08:42 FAX 0332 333027 VAJ ERNESTO & C. SNC * TECHNIGRO 000/000

VAJ L+R C876

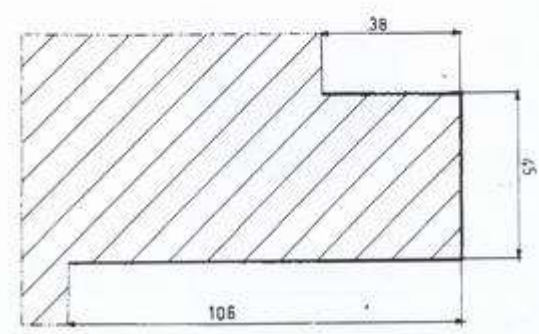
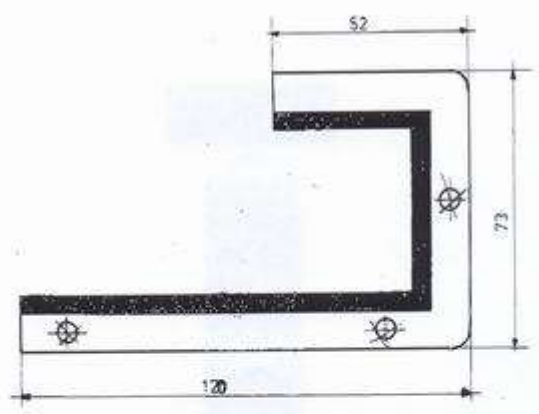

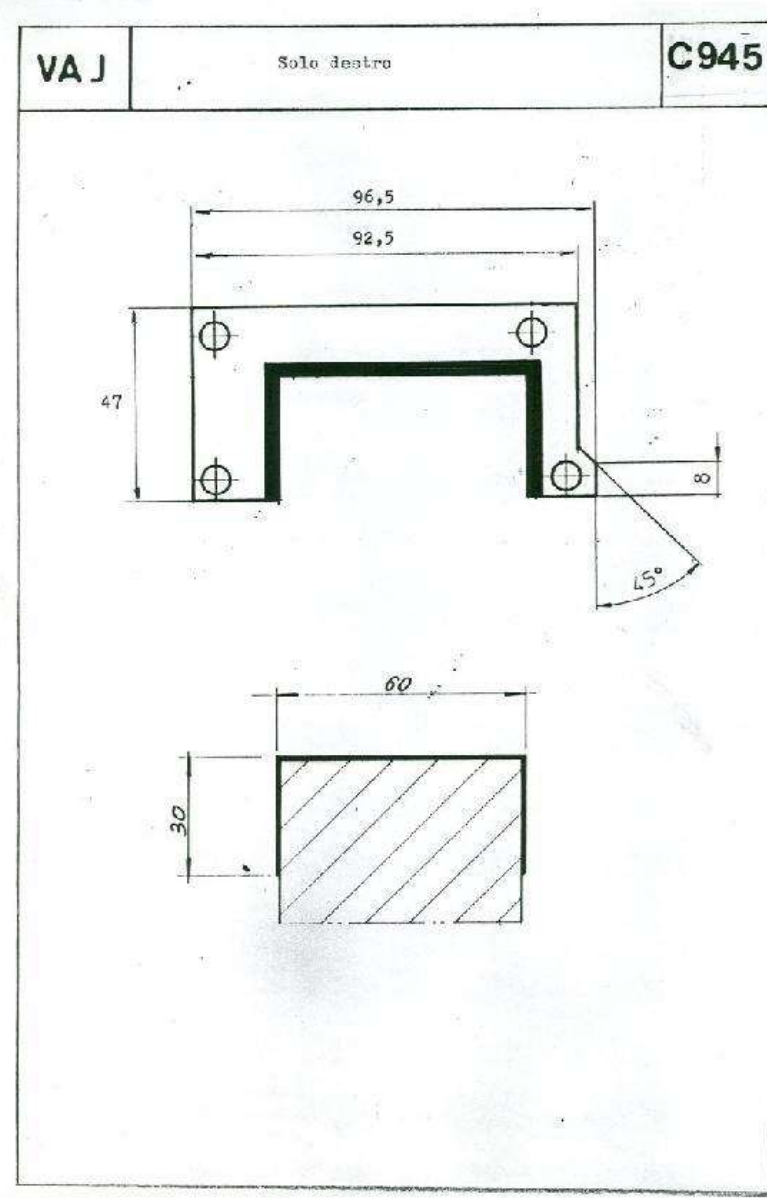
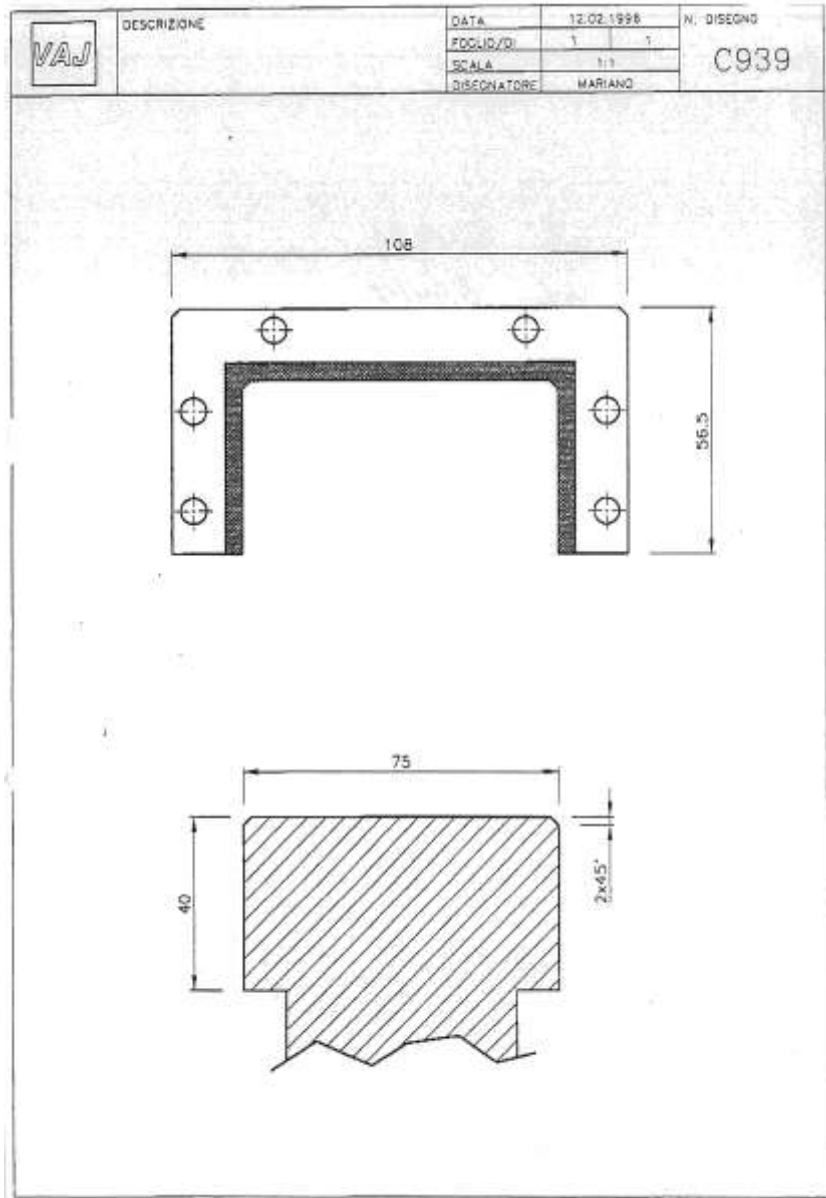

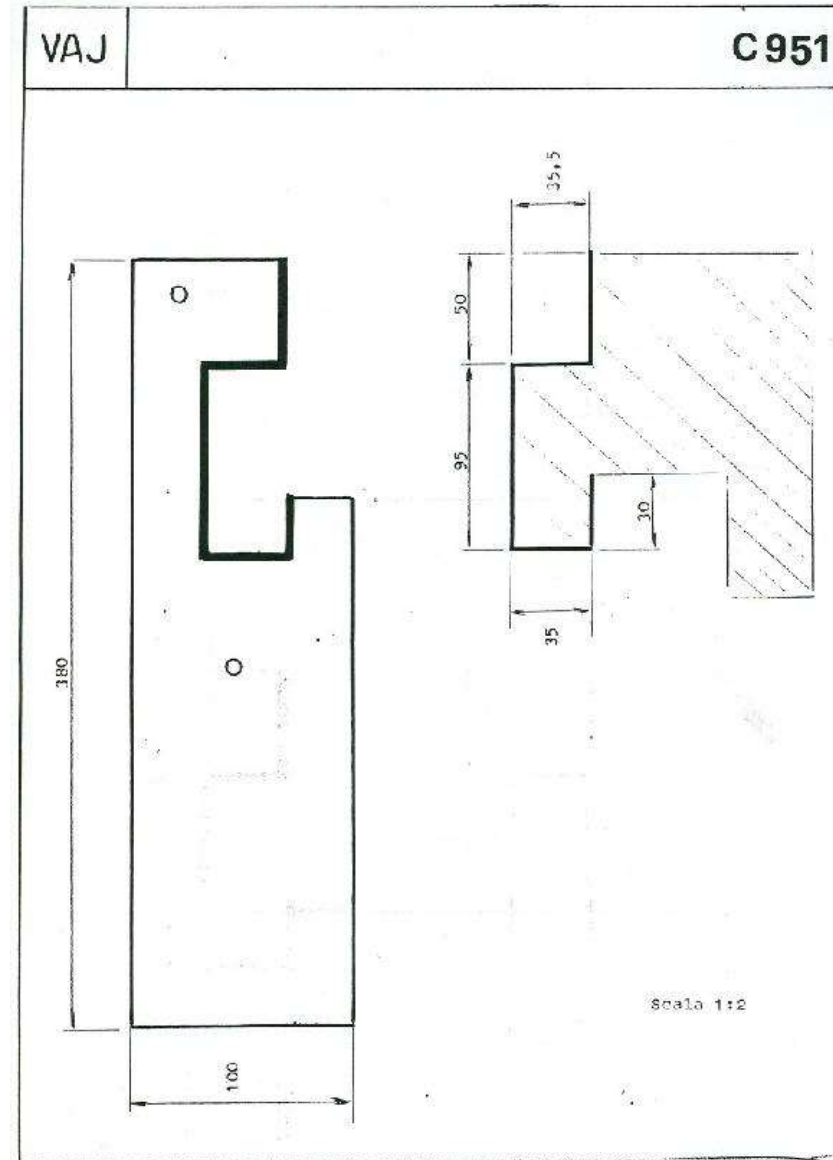
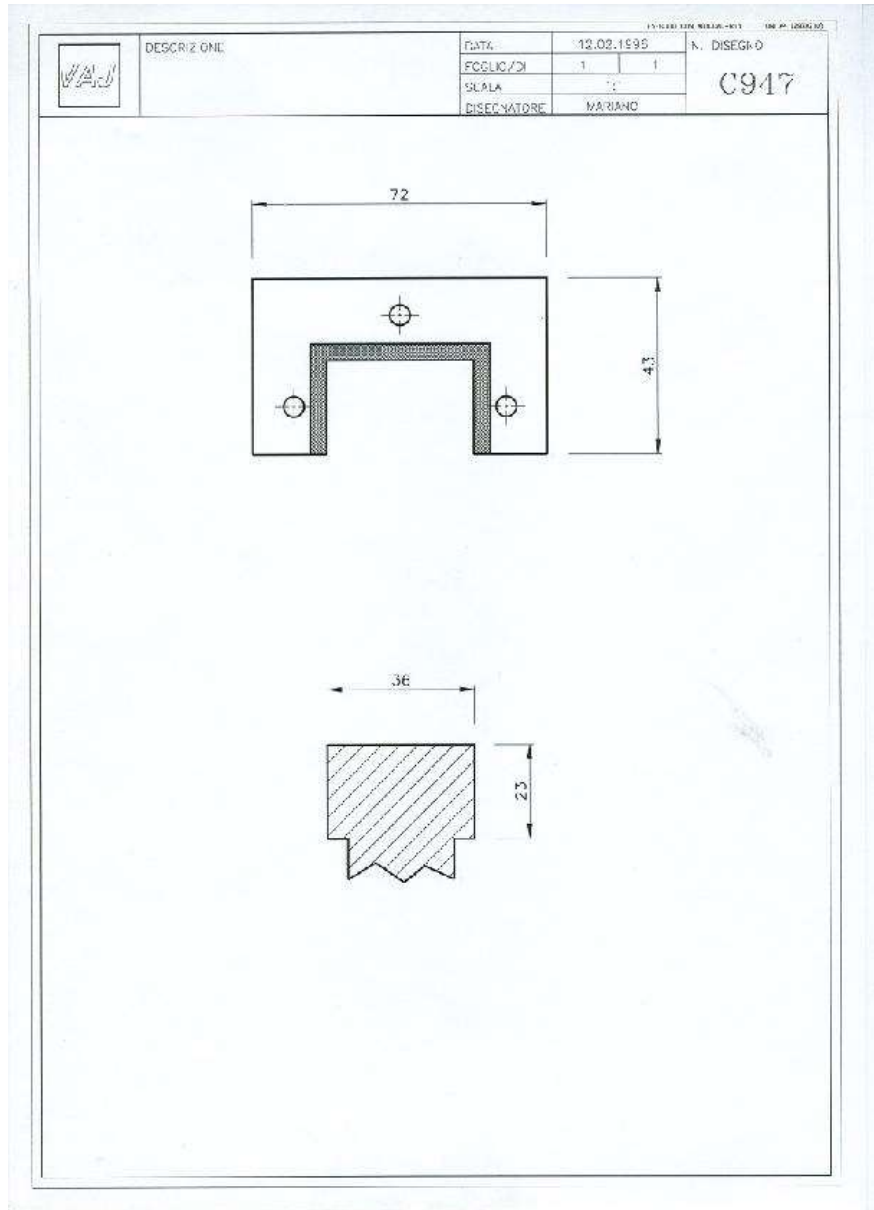

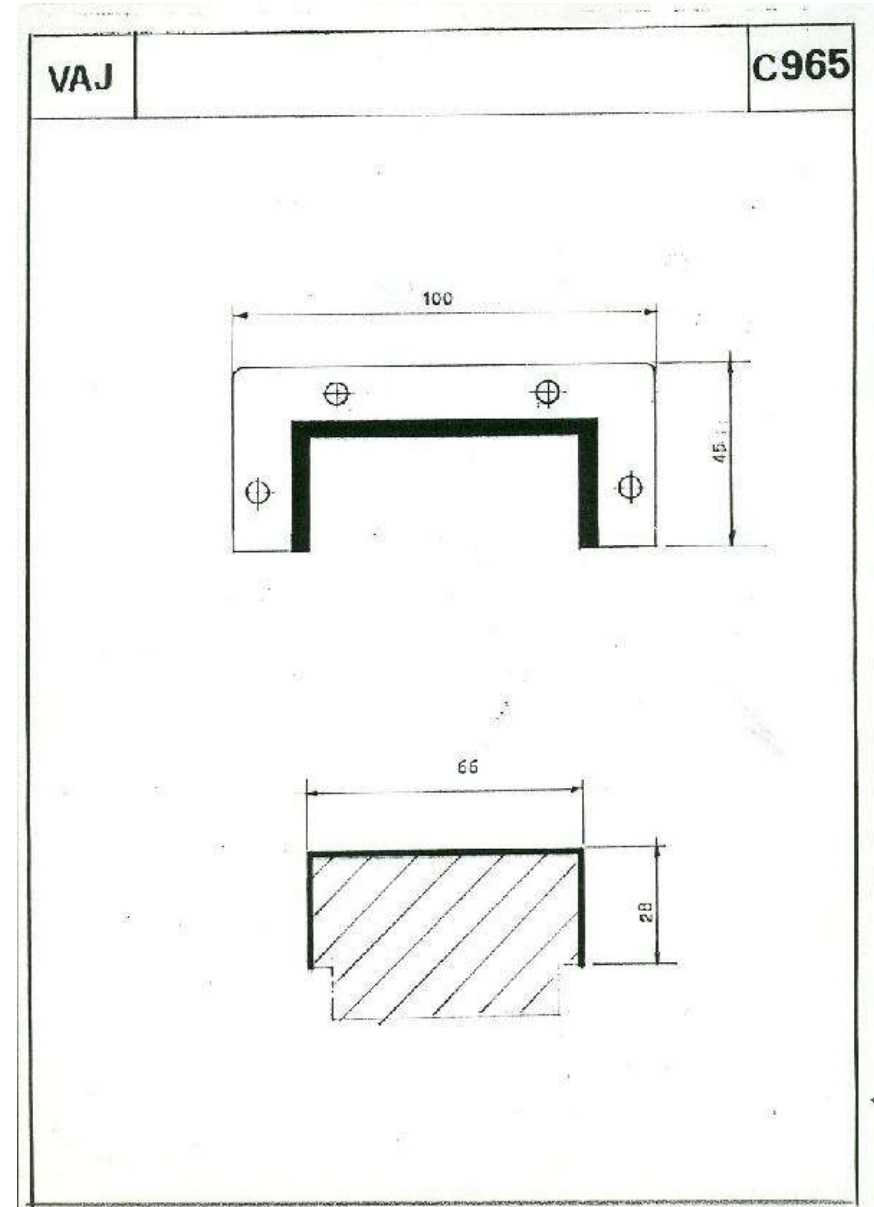
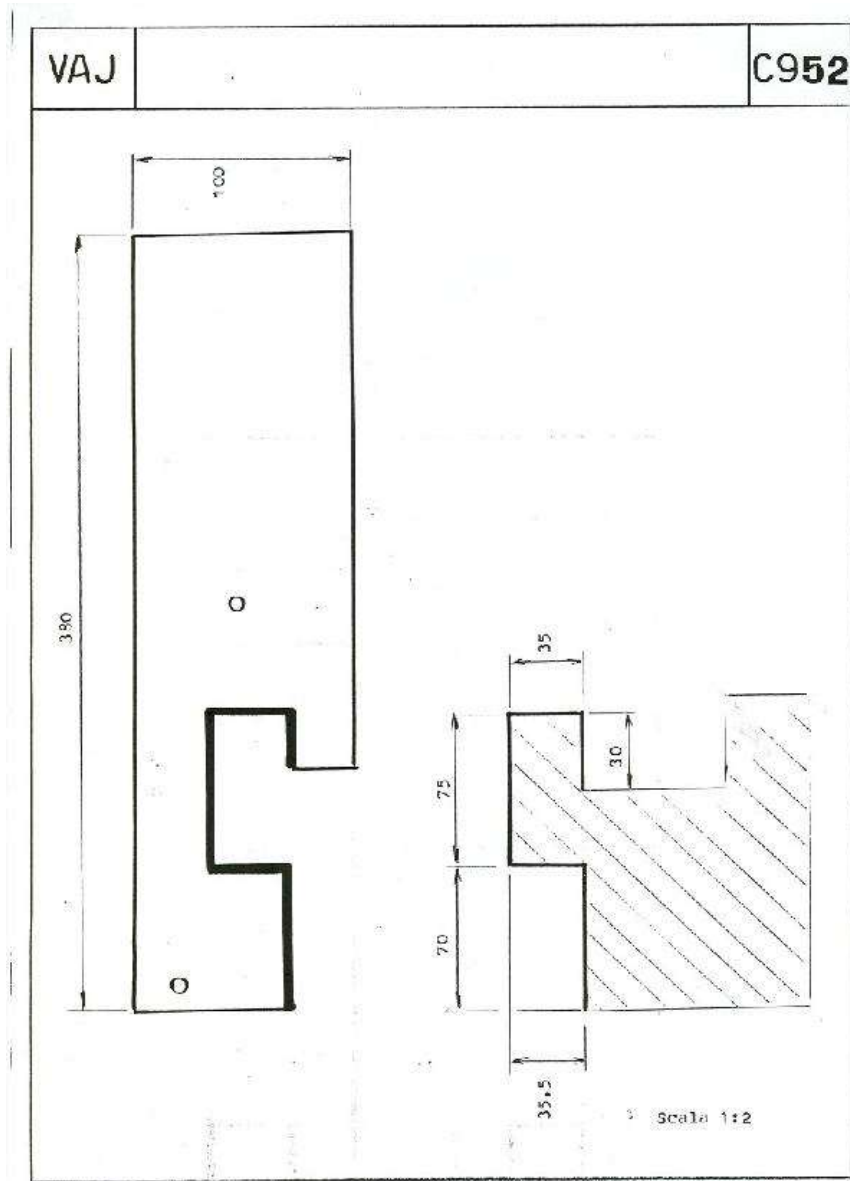

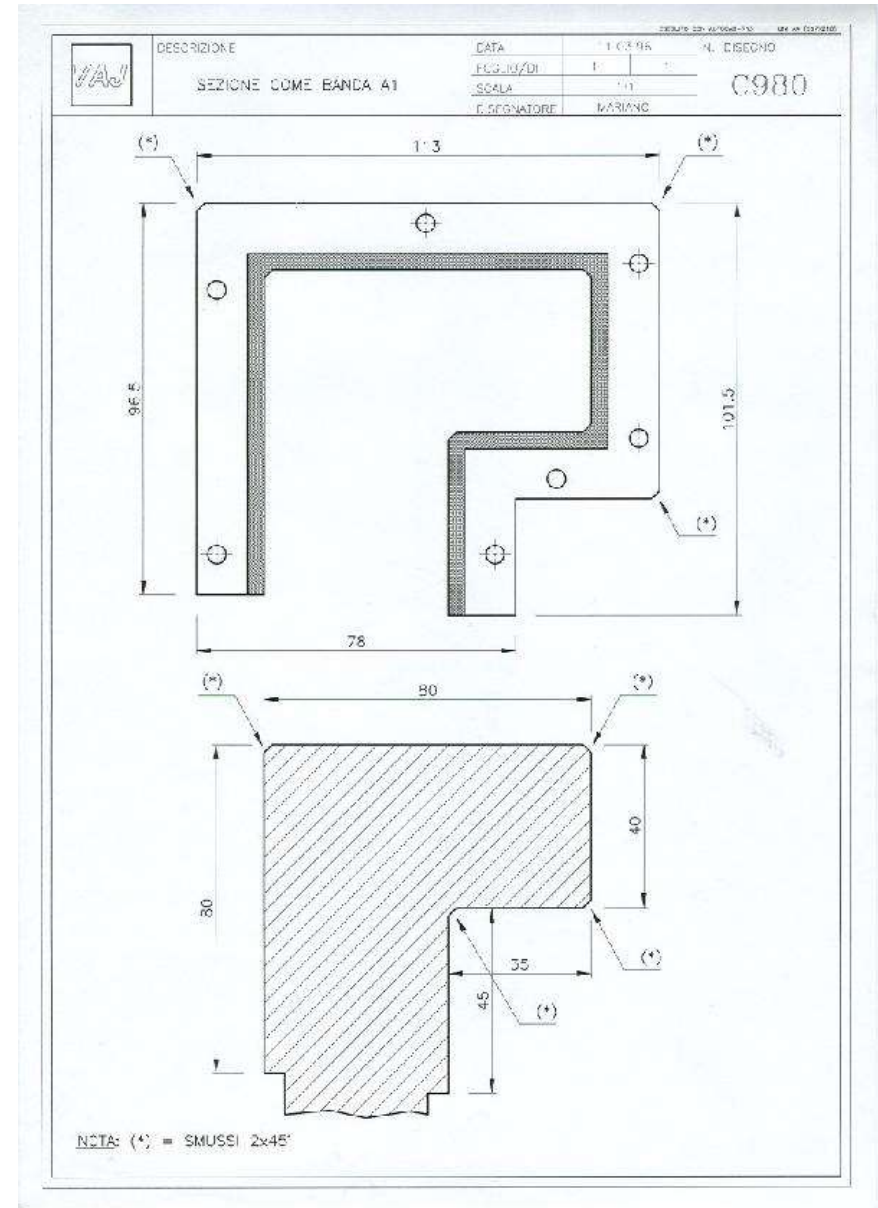
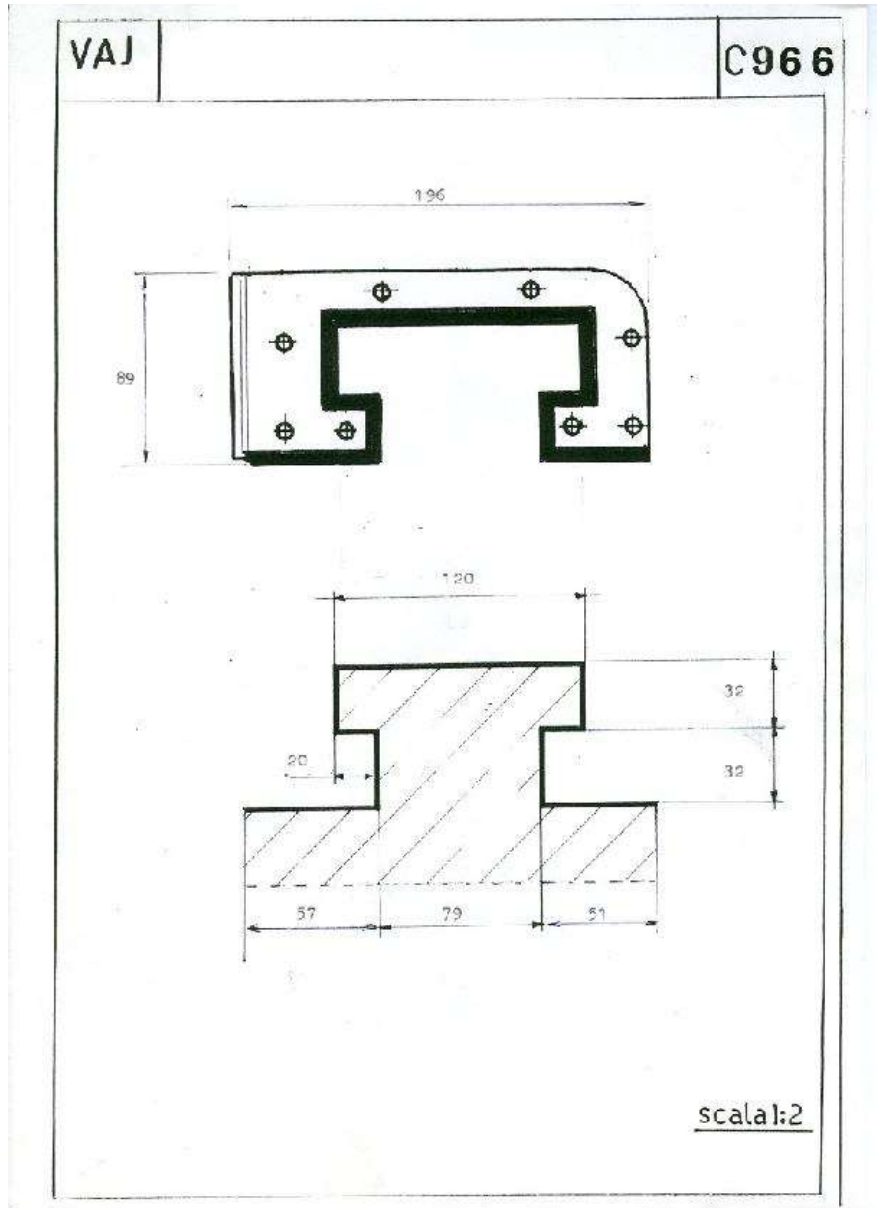

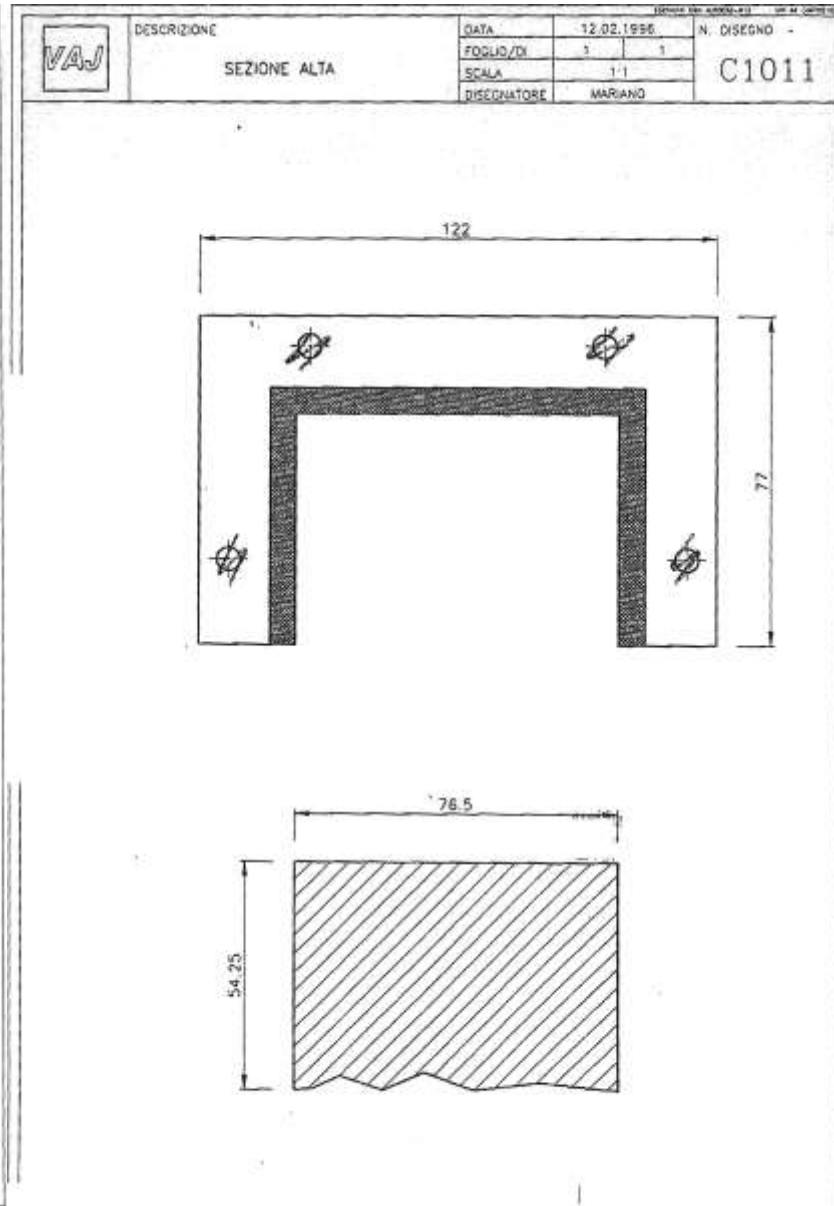
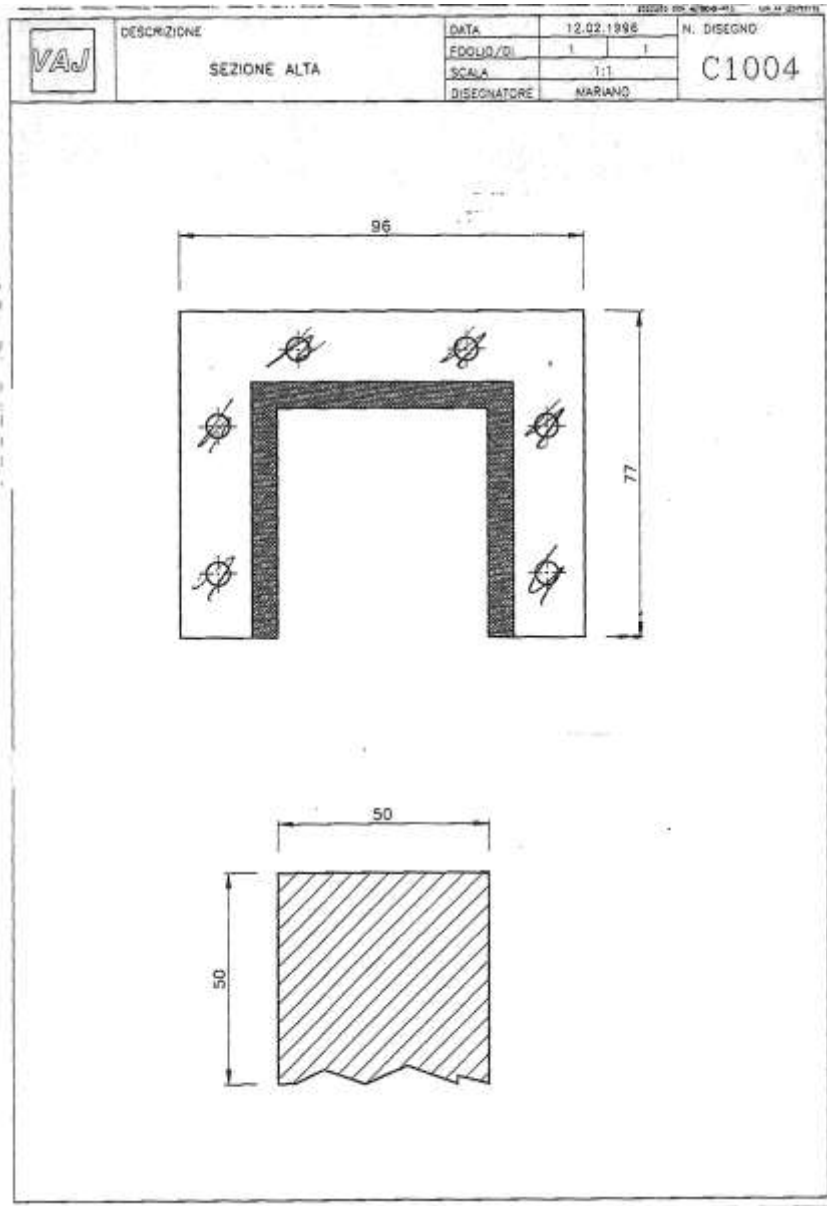

VAJ Sezione alta C 1018

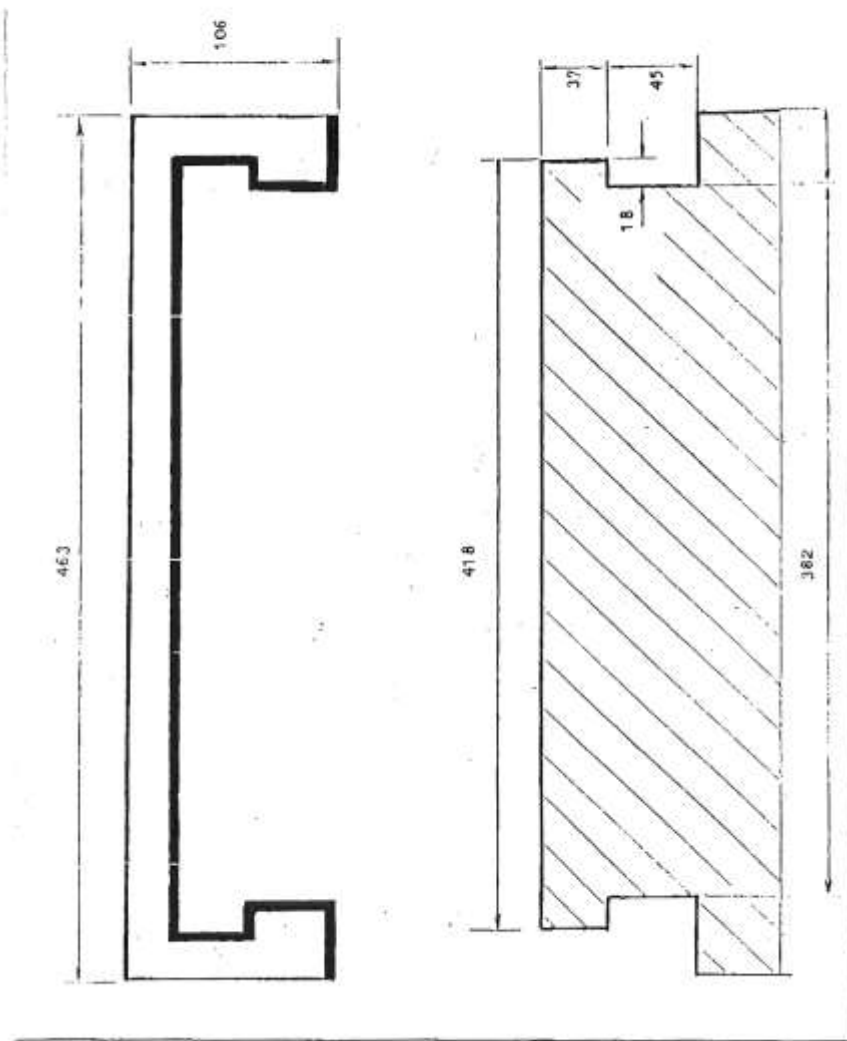

VAJ DESCRIZIONE SEZIONE ALTA DATA 12.02.1998 N. DISEGNO C1020
 FOLIO/DI 1 1
 SCALA 1:1
 DISEGNATORE VARIANO

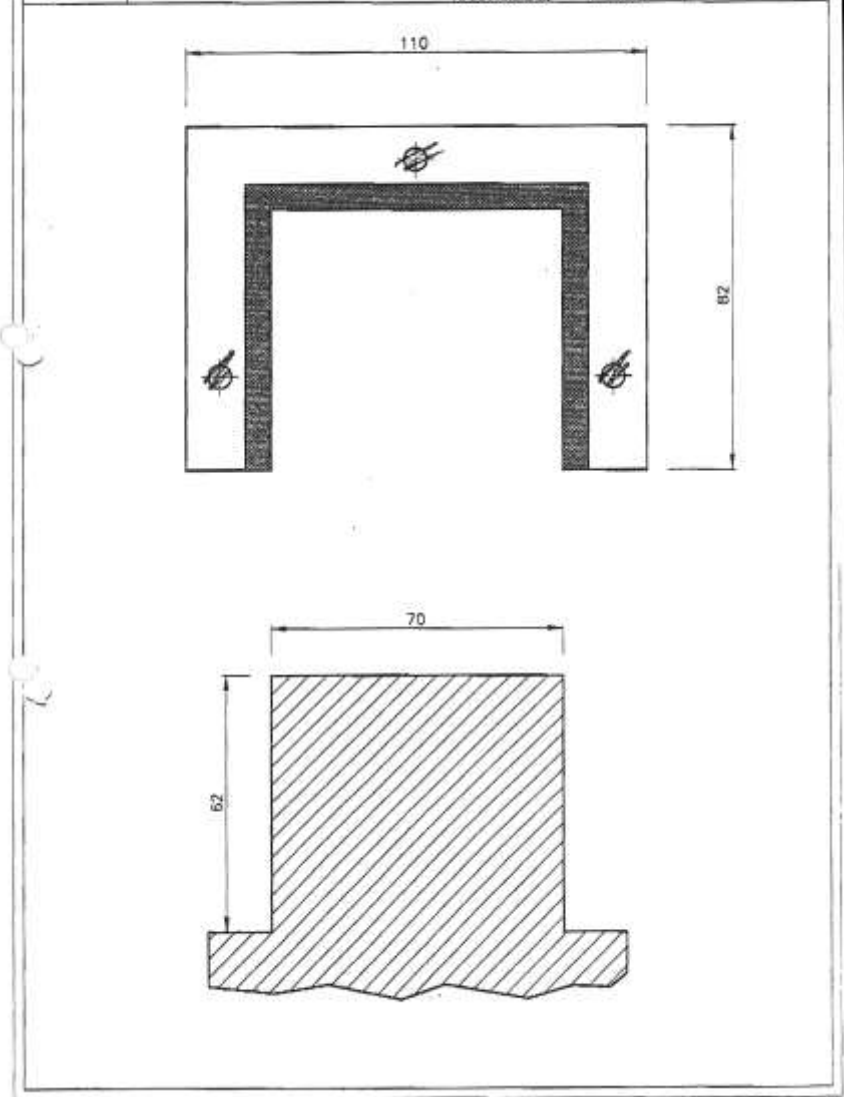

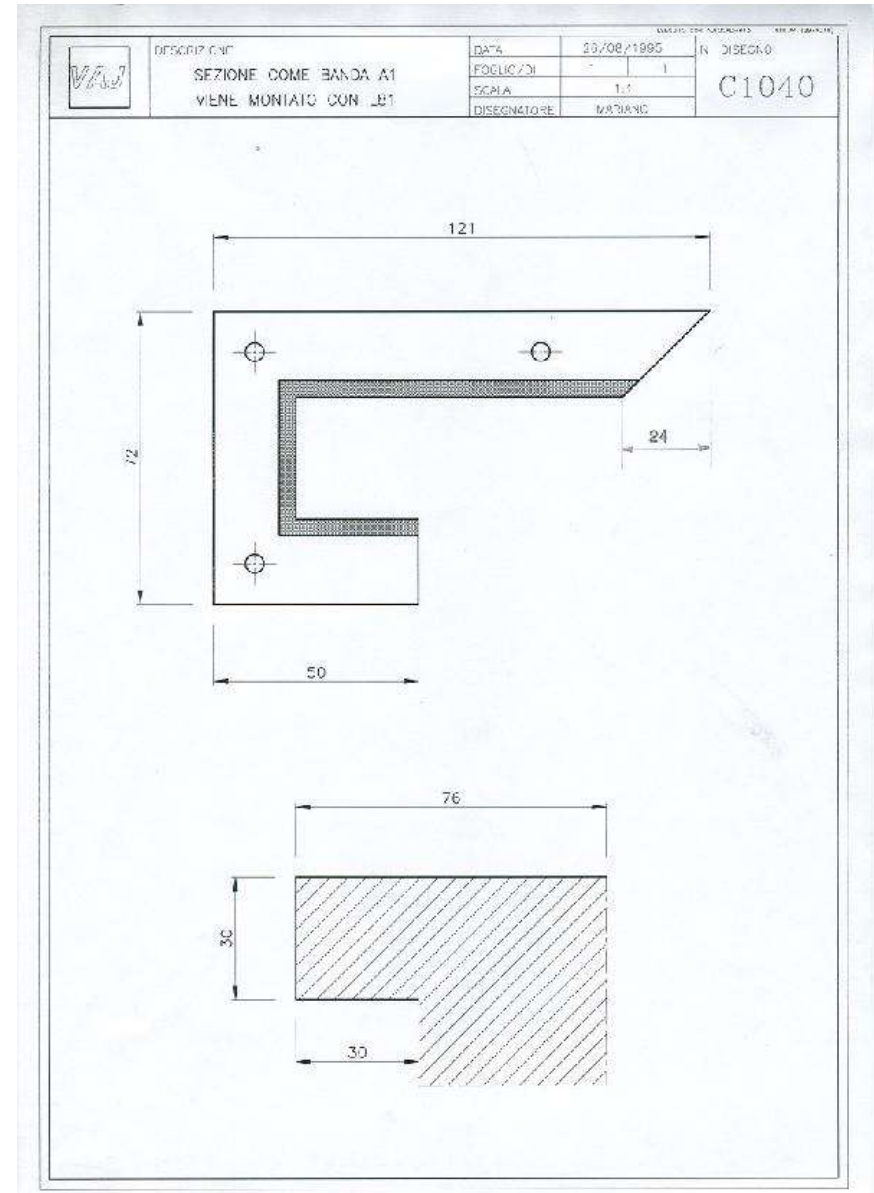
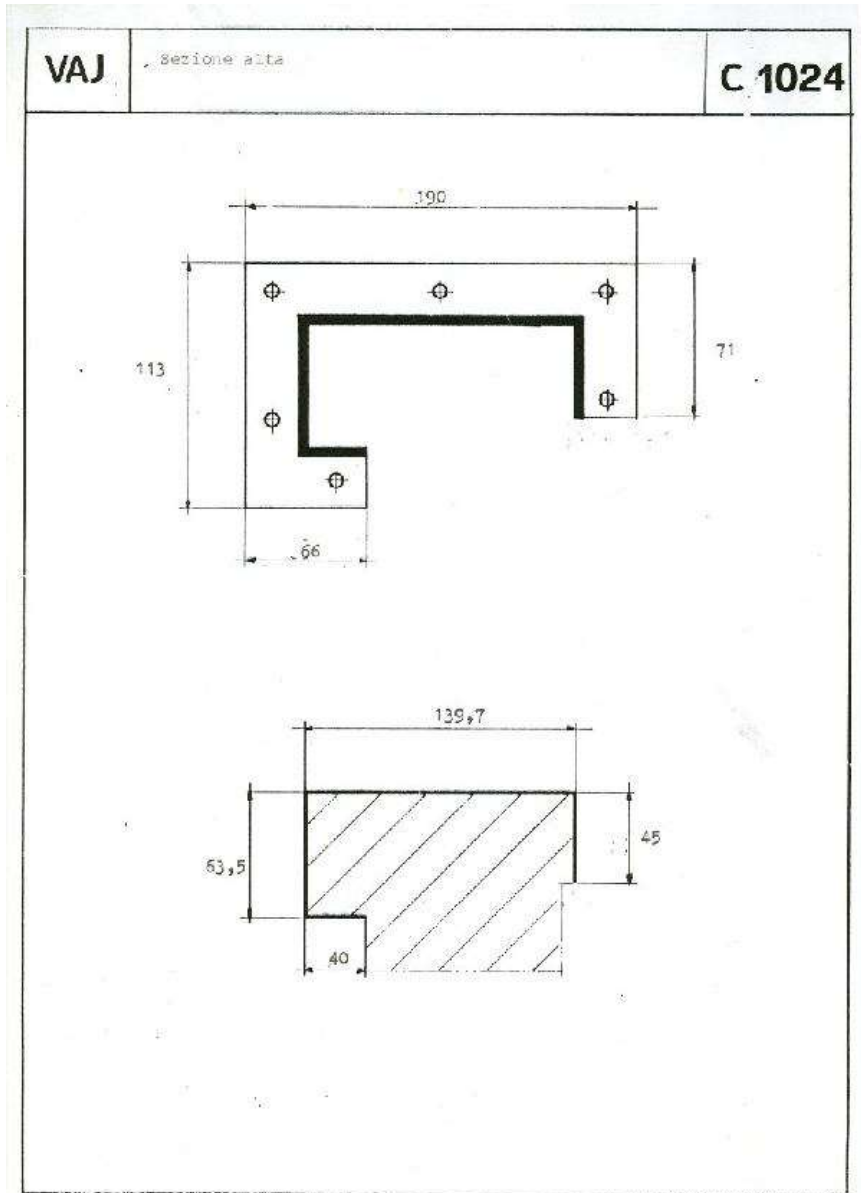

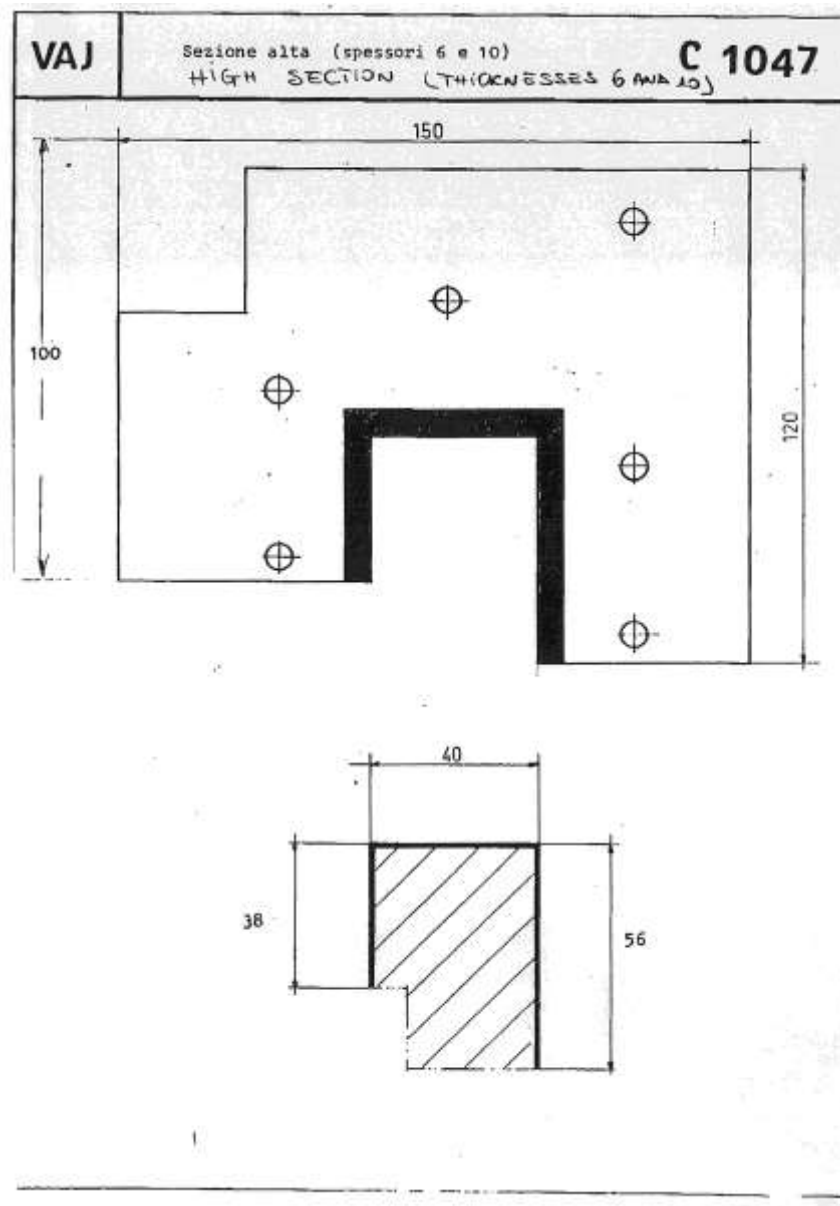
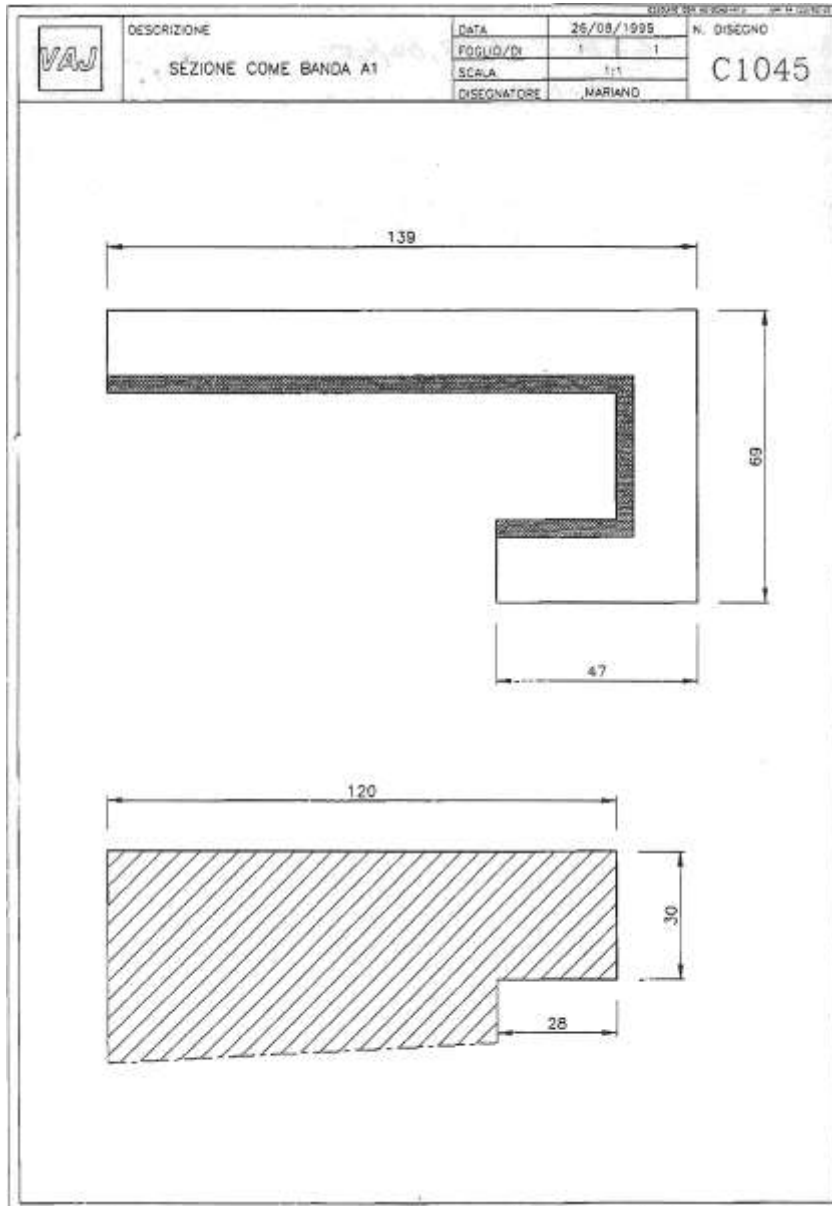

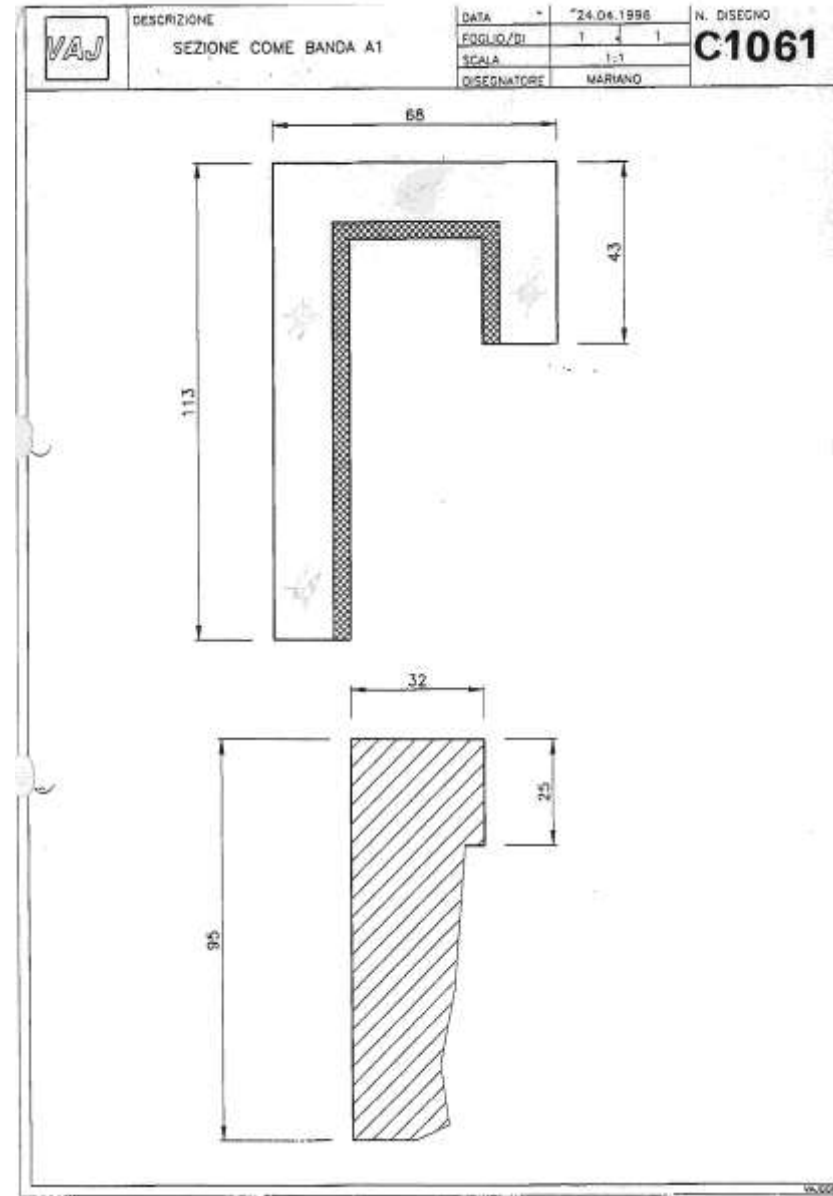
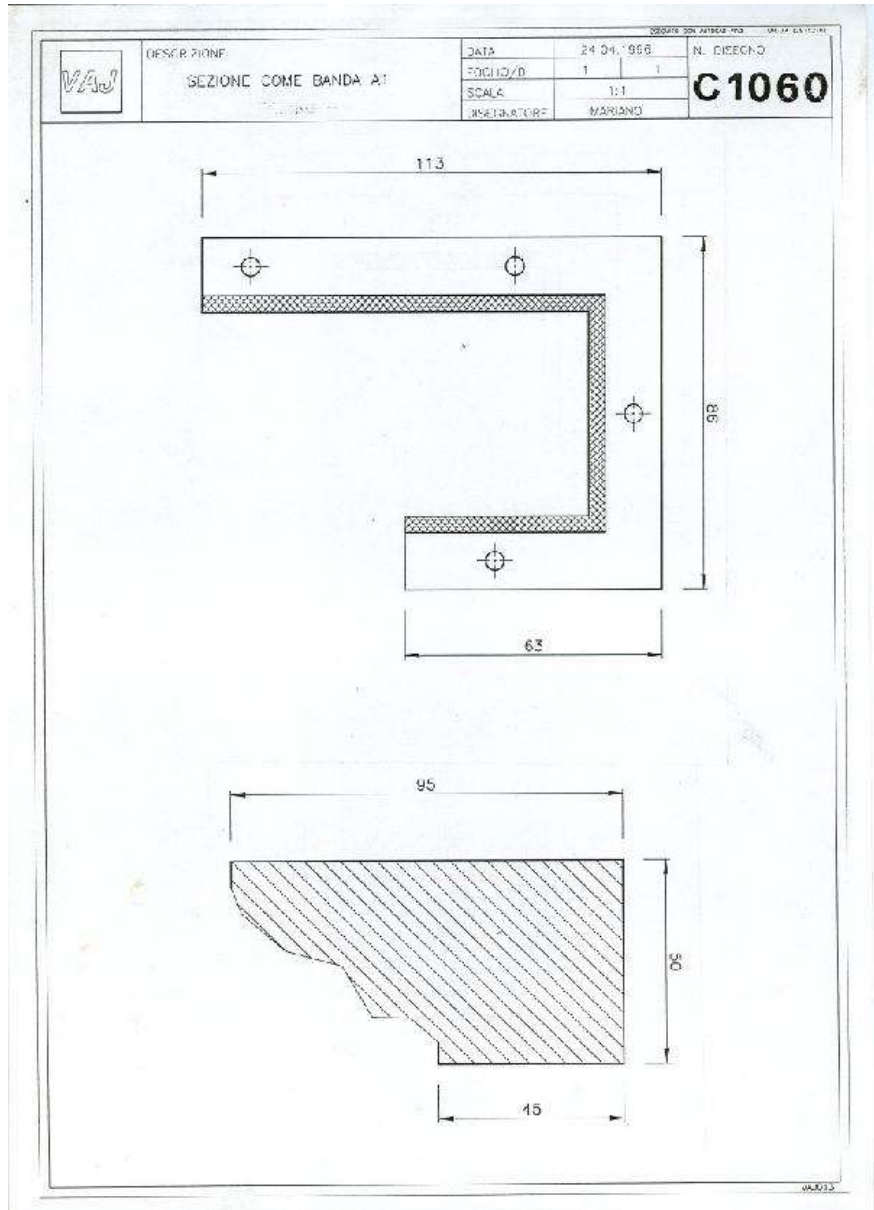

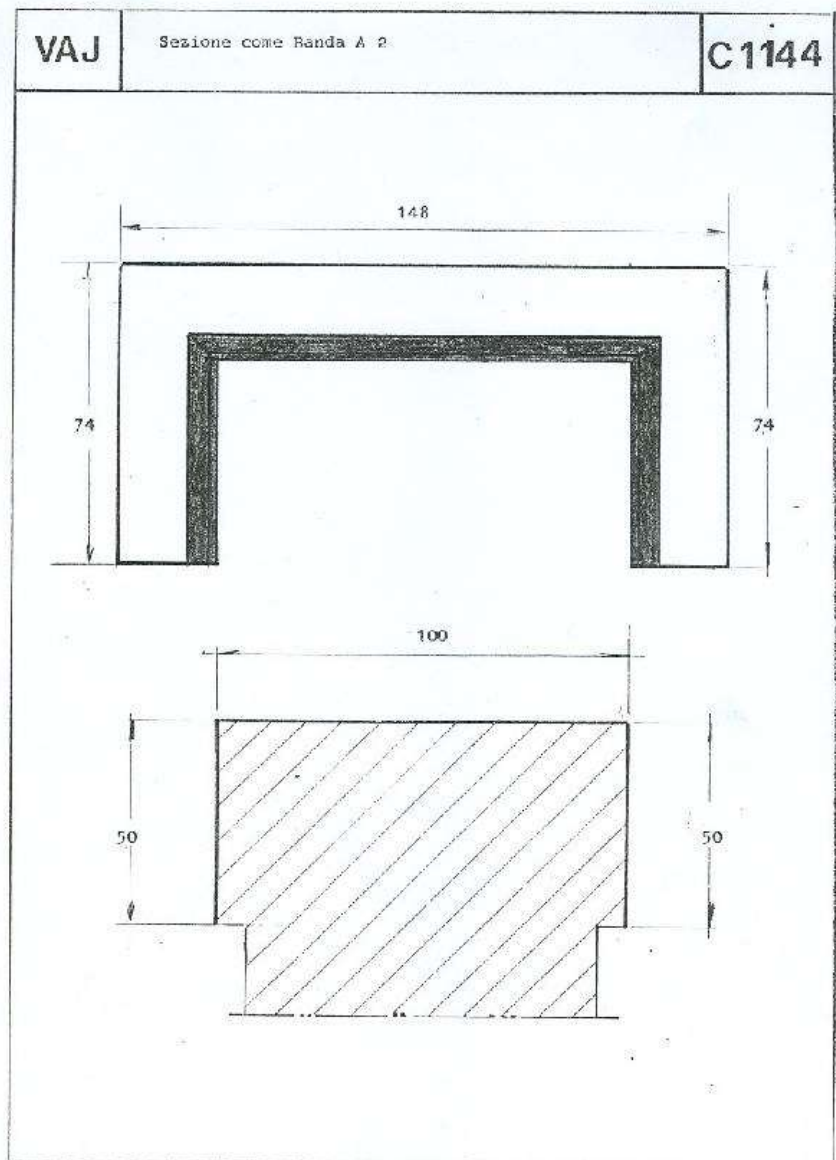

UNI A4

